

**Technical Handbook**  
*Air Handling Technology*



# Index

<b>1</b>	<b>INTRODUCTION</b>	
	Purpose and Objectives of the Manual	9
	Presentation of the manual	9
<b>2</b>	<b>GENERAL INFORMATION ABOUT AIR HANDLING SYSTEM</b>	
	General	11
<b>3</b>	<b>THE PROPERTIES OF AIR</b>	
	Introduction	13
	The dry-bulb thermometer temperature ( $t_{db}$ )	14
	The wet-bulb thermometer temperature ( $t_{wb}$ )	14
	Moisture content ( $x$ )	14
	Enthalpy ( $h$ )	14
	Saturation	14
	Relative humidity ( $\varphi$ )	14
	Mollier Chart	15
	The heating process	16
	The cooling process	17
	Humidification with water or steam	18
	Mixing two air flows	19
	Mixing two airflows – Mist	20
	Different climates in the Mollier Chart	21
	Summary	22
<b>4</b>	<b>FLUID ENGINEERING</b>	
	Introduction	25
	Laminar and turbulent flow	25
	Reynolds Law of Uniformity	25
	Definition of pressure	26
	Flow in pipes and ducts	26
	Pressure drop data	28
	Summary	29
<b>5</b>	<b>HEAT TRANSFER</b>	
	Introduction	31
	Heat conduction	31
	Convection	32
	Radiation	32
	Classification	32
	Summary	33
<b>6</b>	<b>COOLING PROCESSES</b>	
	Introduction	35
	The cooling process	36
	Cooling capacity	37
	Energy consumption	37
	The coefficient of performance for cooling	37
	Coefficient of performance for heating	37
	Summary	38

<b>7</b>	<b>HEAT AND COOLING ENERGY RECOVERY</b>	
	Introduction	41
	Duration chart	42
	Definitions	43
	Efficiency	43
	Summary	45
<b>8</b>	<b>LCC AND ENERGY CALCULATIONS</b>	
	Introduction	47
	The life cycle energy cost, $LCC_E$	47
	Energy cost and $CO_2$ -emission	47
	Minimizing the energy cost	48
	Parameters for energy - and $LCC_E$ -calculation	48
	Temperature calculation	48
	Outdoor temperature compensation	49
	Running times	49
	VAV-system	50
	Duration chart	50
	Summary	51
<b>9</b>	<b>SOUND</b>	
	Introduction	53
	Sound	53
	Frequency	54
	Standard filter	55
	What generates sound in an air handling unit?	55
	The relation between sound power and sound pressure	56
	Outdoors	56
	Indoors	56
	Sound level in utilized spaces	57
	How to select a quiet air handling unit	57
	Summary	58
<b>10</b>	<b>DAMPERS</b>	
	Introduction	61
	Regulation of airflows	61
	Mixing of airflows	61
	Mixture properties	62
	Regulation of by-pass airflow	63
	Shut off	63
	Damper blades	64
	Air leakage from closed air damper	65
	Air leakage in the air damper casing	65
	Required torque	65
	Pressure	65
	Summary	66
<b>11</b>	<b>FILTERS</b>	
	Introduction	69
	Impurities in the air around us	69

How does a particle filter work? _____	70
Testing and classification of particle filters _____	72
Pressure drop across particle filters _____	73
Carbon filters (Sorption filters) _____	74
Filters in air handling units _____	74
Pre-filters _____	74
Fine filters _____	75
High efficiency HEPA filters _____	75
Carbon filters _____	76
Installation _____	76
Summary _____	77

## **12      SOUND ATTENUATORS**

Introduction _____	79
Sound attenuation _____	79
Absorption sound attenuation _____	79
Reactive sound attenuation _____	79
Width _____	80
Length _____	80
Pressure drop _____	80
Sound generation _____	81
Location _____	81
Method of measurement _____	81
Summary _____	82

## **13      FANS**

Introduction _____	85
Fan types _____	85
Centrifugal fans _____	86
Plenum fans _____	87
Axial-flow fans _____	87
Fan chart _____	88
Fan laws _____	89
System curves _____	90
Compatibility between fan and system curve _____	90
Effects of changed system characteristic _____	90
Parallel operation of fans _____	91
System effects _____	92
Duct bends _____	92
Louvre damper _____	92
Fan efficiency _____	92
Temperature rise through the fan _____	92
Fan impeller balancing _____	93
Natural frequency _____	93
The natural frequency of the anti-vibration mountings _____	93
Permissible vibration velocity _____	93
Sound _____	93
Vibration isolation _____	94
The drive system of the fan _____	95
Direct drive _____	95
Belt drive system _____	96
Belt drive operation _____	96
V-belt drives _____	96
Flat belt drives _____	96

Flat belt drives	96
MICRO-V or poly-V belt drives	96
Fan motors	97
Three-phase induction motors	97
Torque	97
The motor efficiency	98
Direct on-line starting of single speed motors	98
Star-delta starting of single-speed motors	98
Start and control of two speed motors	98
Motor protection (overload protection)	98
Equipment for heavy Starting	98
Phase failure protection	98
EC motors	99
High efficiency	99
Speed control	99
EC motor characteristics	99
High-efficiency electric motors	100
Starting time – for motors without frequency inverter	100
Check of permissible starting time of the motor	101
Check of the overload protection device's tripping time	101
Motor wiring diagram	101
SFP value	102
SFPv-value	102
Power efficient fans	103
Controls	103
Summary	104

## 14

### AIR HEATERS AND AIR COOLERS

Introduction	107
Design	108
Various modes of connection	108
Coil circuits	109
Coils for evaporative refrigerant	110
Break-down into output stages, marking	110
Normal velocities for coils	110
Cooling units	111
The evaporator	111
The compressor	111
The condenser	111
Expansion valve	111
High pressure switch	112
High pressure switch (in-operation)	112
Low pressure switch	112
Liquid filter	112
Sight glass	112
Passive refrigerant collection container	112
Water cooled condenser	112
Selection of cooling unit	112
Indirect Evaporative Cooling	113
Extract air humidification or outdoor air humidification	114
Calculation of cooling power	114
Night-time cooling	114
Total energy	114

Safe	114
Electric air heaters	115
Summary	115

## **15 HEAT EXCHANGERS FOR RECOVERING AND COOLING ENERGY**

Introduction	117
Rotary heat exchangers	118
Purging sector	119
Frosting	120
Defrosting	120
Corrosion protection	120
Application	120
Hygroscopic and non-hygroscopic rotor	121
System with double rotors	123
Plate heat exchangers	124
Design	124
Frosting and defrosting	124
Leakage	124
Corrosion protection	124
Liquid-coupled systems	125
Design	125
The system	125
Efficiency	125
Regulation and frost control	125
Anti-frost protection medium	125
ECONET®-system	126
How the system operates	126
Temperature efficiency and pressure drop	127
System comparisons	127
Summary	128

## **16 HUMIDIFIERS**

Introduction	131
Humidification principles	131
Contact humidifiers	132
Operation	132
Hygiene	132
Control	132
Steam humidifiers	133
Nozzle humidifiers	133
Water quality	133
Summary	134

## **17 CONTROLS**

Introduction	137
Dynamic Properties	138
Various Controllers/Control Principles	139
On/off control	139
Multi-step control	139
Proportional control (P control)	140
Integral control (I control)	140
PI control	141
PID control	141

Cascade control	141
Control unit in air handling units	142
Supply air control	142
Extract air control	142
Room control	143
Flow and pressure control (fan control)	143
Sequence control	145
Examples of control in various HVAC functions	146
Rotary heat exchanger	146
Plate heat exchanger	146
Liquid-coupled heat exchangers	147
Heating and cooling coils	147
Water flow control	147
Shunt control	148
Electric air heater	149
Extra functions	149
Outdoor compensation	149
Night-time heating	150
Night-time cooling (Free cooling)	150
CO <sub>2</sub> compensation	151
Operation management	151
Anti-frosting protection	151
Alarms	151
Communication	152
Summary	153

## **18 MEASUREMENT TECHNOLOGY AND STANDARDS**

Introduction	155
Measurement accuracy	155
Temperature	156
Thermocouples	156
Resistance gauges	156
Pressure & Flow	156
Diagram pressure gauges	156
Liquid column, U-tube	157
Calculation of Airflows	157
Atmospheric Humidity	158
Standards	158
Summary	159

## **19 FORMULAS**

Collection of Formulas	161
Formulas	164
The Properties of Air	164
Fluid Engineering	164
Heat Transfer	165
The cooling process	165
Heat and Cooling Energy Recovery	166
Sound	167
Fans	168
List of Sources	170





# Introduction



# Purpose and Objectives of the Manual

This technical manual should be seen as a complement to the product and ventilation engineering catalogues which describe various air handling units from Fläkt Woods. In this manual, we have gathered information which is important to know for the project design, selection and installation of air handling units and the components incorporated into their unit sections. Our purpose with this manual is to give you a deeper knowledge about air handling technology and air handling units.

## Presentation of the manual

This technical manual is composed in two main parts. The first chapters provide a theoretical understanding of the processes taking place in and around the components in the air handling unit. The subsequent chapters enable you to follow the design and makeup of the air handling units. They begin with the dampers and then go on to the filters in the air handling unit, and so on. The end of the manual provides formulas.

Each chapter has a box, on the first page, containing a description of what the chapter contains.

A summary of the information presented appears at the end of each chapter.

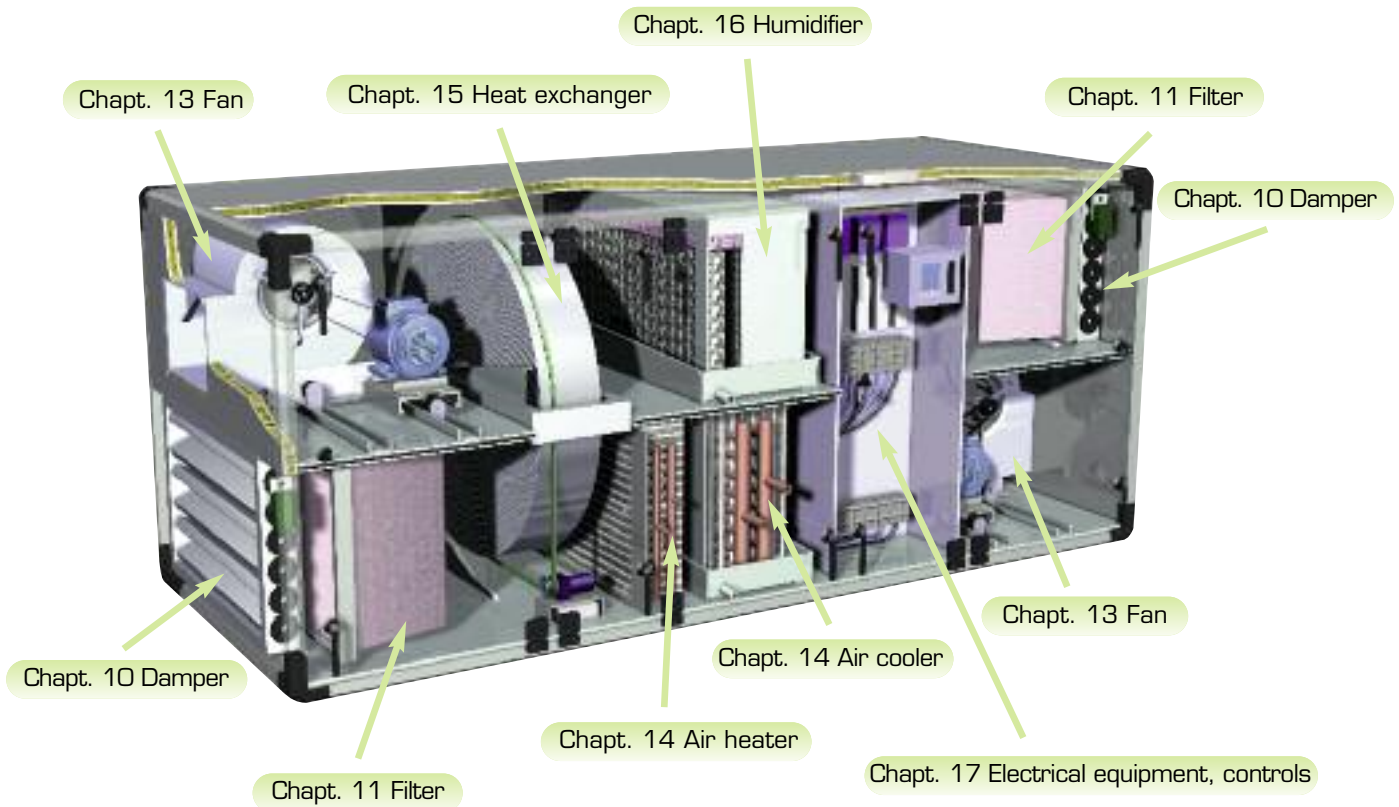

# General information about air handling systems



Air handling units clean, condition and transport the air which should contribute to good comfort and good indoor climate in buildings. They can also be used in order to add air with a specific composition to industrial processes.

We often ventilate rooms in order to transfer away polluted air. The pollution may, for instance, consist of impurities or, as in offices, excess heat. Excess heat may be regarded as a type of pollution you wish to dispose of. Supply air is required for replacing the air that has been removed. This air should be supplied at the correct temperature, free of draught and without disturbing noise.

The air handling unit is equipped with a filter which cleans the air before it is supplied to the room. The different types of air filters have different functions. Their function is to either remove particles, vapour or gases from the air.

The outside air temperature and humidity change continuously and can vary from extreme moist heat to intense dry cold. In a comfortable indoor climate the temperature can vary between approx. 19°C and approx. 26°C. The air handling unit either heats up or cools down the outside air to the desired indoor temperature. This is done by means of heating coils or cooling coils.

The humidity of the air can also be controlled. When it is too low, humidifiers can be used in order to add moisture to the air. When it is too high, a cooler, for instance, can be used in order to condense the moisture and reduce the humidity.

The supply air fan sucks the air through the air handling unit and blows it out through the duct system to the rooms in the building. In the meantime, the fan generates sound as a by-product. Sound absorbers can be installed in the air handling system in order to attenuate the sound emitted to the rooms. Fans increase the air temperature since they put the air in motion and this generates heat. When air is supplied to a room, it is normally necessary to equip the

room with an extract air and an exhaust air system, which removes a similar volume of air from the room. A fan is used in order to extract the air from the room.

In northern Europe the extract air is normally warmer than the outside air, especially during the winter. In order to reduce the building's running costs, heat exchangers are often used to take heat from the extract air to heat up the outdoor air. In areas where the climatic conditions are the opposite, i.e. the extract air is colder than the outside air; cooling energy recovery can instead be used.

All the above mentioned processes are performed by components, incorporated into the air handling unit, which has an insulated, air tight and stable casing.

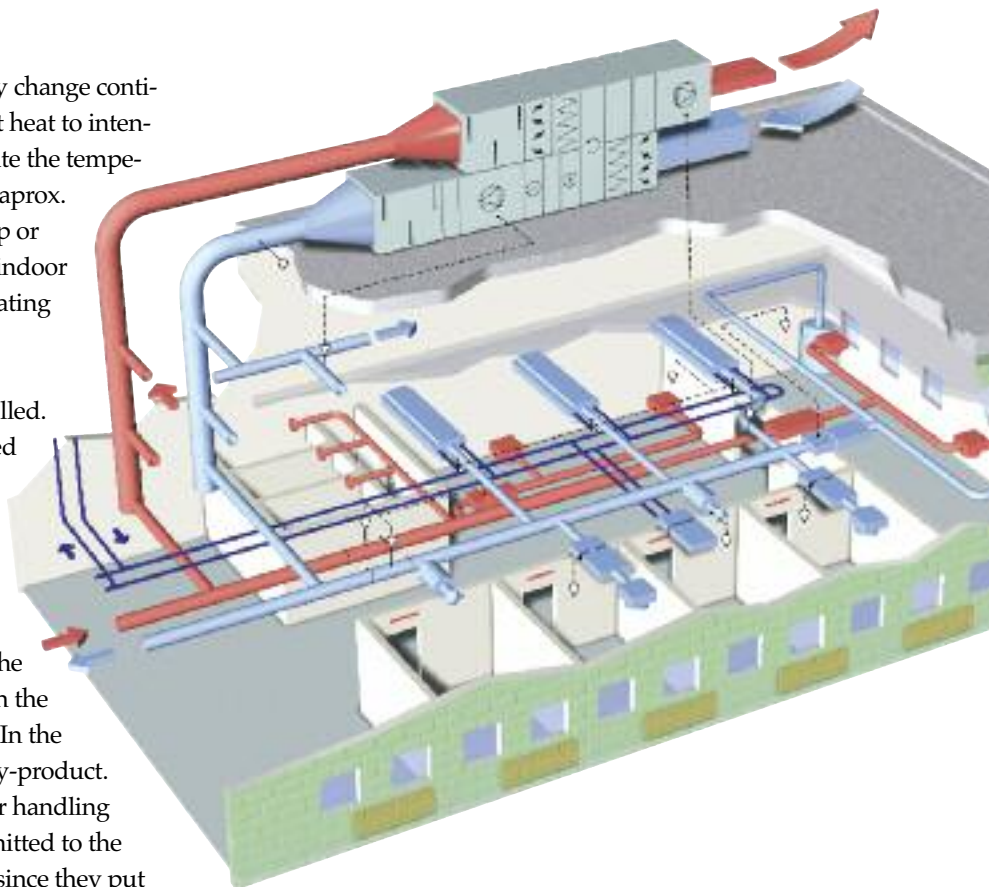

A typical air handling unit in a ventilation system

# 3

## The properties of air



### The chapter deals with the following

- The properties of air
  - Temperature
  - Water content
  - Enthalpy
  - Relative humidity
- Mollier chart

Outdoor air consists of a mixture of many gases (mostly nitrogen and oxygen), vapour (mostly water) and dust particles.

In order to understand the processes which take place in an air handling unit we only need to think of air as a mixture of dry air and water vapour. We call this mixture moist air. There is a limit to how much

water vapour the air can carry. This limit is called saturation. The saturation limit depends on the temperature and the air pressure.

When it comes to air handling, we normally regard air as a gas mixture with standard atmospheric pressure. When air at constant pressure is saturated, it can no longer absorb any more humidity, as long as it is not heated.

If the saturated air is cooled down it gives off condensate. This is what happens when the bathroom window becomes moist in the winter time. Many terms are used in order to describe the properties and the condition of moist air. In order to define the condition of moist air we must know the air pressure and two other independent properties.

When designing an air handling system, it is important that the person doing the design work knows what the properties of the air are. This is necessary in order to meet the demands made on the indoor climate.

## Terminology

---

The various terms below describe the properties and the condition of air.

### The dry-bulb thermometer temperature ( $t_{db}$ )

The temperature we measure with an "ordinary" thermometer, for example the one we read the indoor temperature off of at home, is called a dry-bulb thermometer. When you choose an air heater, air cooler and humidifier for air handling units we utilize the dry-bulb thermometer temperature as one of the two terms needed.

### The wet-bulb thermometer temperature ( $t_{wb}$ )

If the bulb on a thermometer is wrapped in cloth soaked in water, the evaporation of the water from the wick will cool down the bulb of the thermometer, which will result in that the thermometer will show a lower temperature. The drier the air is the more water can evaporate and the more the temperature decreases. In this way, the wet-bulb thermometer temperature can be used as a measure of the humidity in the air.

### Moisture content ( $x$ )

The moisture content describes the amount of water present in the air. It is normally described as kilograms of water per kilogram of air. Room air generally contains about 5-10 grams of water per kg of air.

### Enthalpy ( $h$ )

Enthalpy is expressed in kJ/kg and describes the quantity of energy in the air compared to a zero degree reference point (Celsius).

In the SI system, the zero degree reference point for enthalpy is defined as 0 °C and zero water content. When the air is influenced to change enthalpy energy is either added or taken away.

### Saturation

The degree of saturation in the air is measured in percent and is calculated by dividing the current water content in the air by the water content the air has when it is saturated.

### Relative humidity ( $\varphi$ )

The relative humidity of the air is measured as a percentage and is the ratio between the partial pressure of the water vapour and the partial pressure of the water vapour when the air is saturated. Thus this is the portion of water vapour in relation to the maximal possible amount of water vapour at the current temperature.

# Mollier Chart

The Mollier Chart is used in order to design air conditioning processes and in order to calculate among others the change in temperature and humidity or the energy required to heat or cool the air. In Fläkt Wood's product selection software, ACON, a Mollier Chart with the specific air handling unit process can be plotted automatically.

**Symbols used:**  
 h = enthalpy per kg dry air; kJ/kg, kcal/kg  
 x = water content per kg dry air; kg/kg  
 φ = relative humidity  
 t = dry-bulb thermometer temperature °C  
 t<sub>v</sub> = wet-bulb thermometer temperature °C  
 ρ<sub>t</sub> = Density kg dry air/m<sup>3</sup> moist air  
 ρ = Density kg moist air/m<sup>3</sup> moist air

The chart refers to barometer pressure = 760 mm Hg = 101.3 kPa

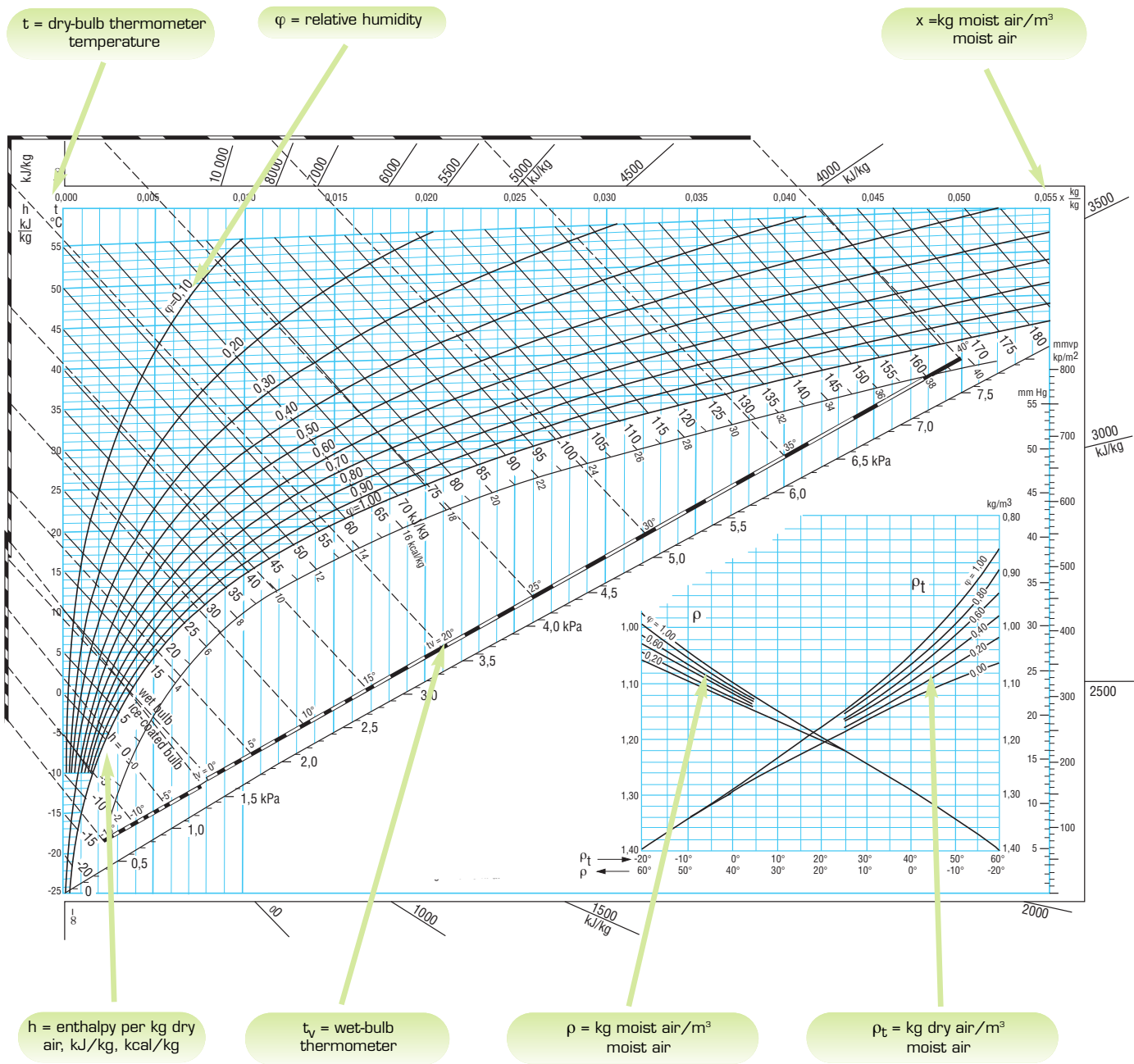



## The heating process

In the heating process, the water vapour content does not change and the process is plotted as a straight and vertical line. Both the enthalpy and the dry-bulb thermometer temperature increase.

The following formula can be used for calculating the required heating power (P):

$$P = \Delta h \cdot q_v \cdot \rho_t = (h_B - h_A) \cdot q_v \cdot \rho_t$$

Där

$P$  = Heating power, kW

$\Delta h$  = change in enthalpy per kg dry air, kJ/kg

$q_v$  = airflow m<sup>3</sup> moist air/s

$\rho_t$  = density in kg of dry air/m<sup>3</sup> moist air

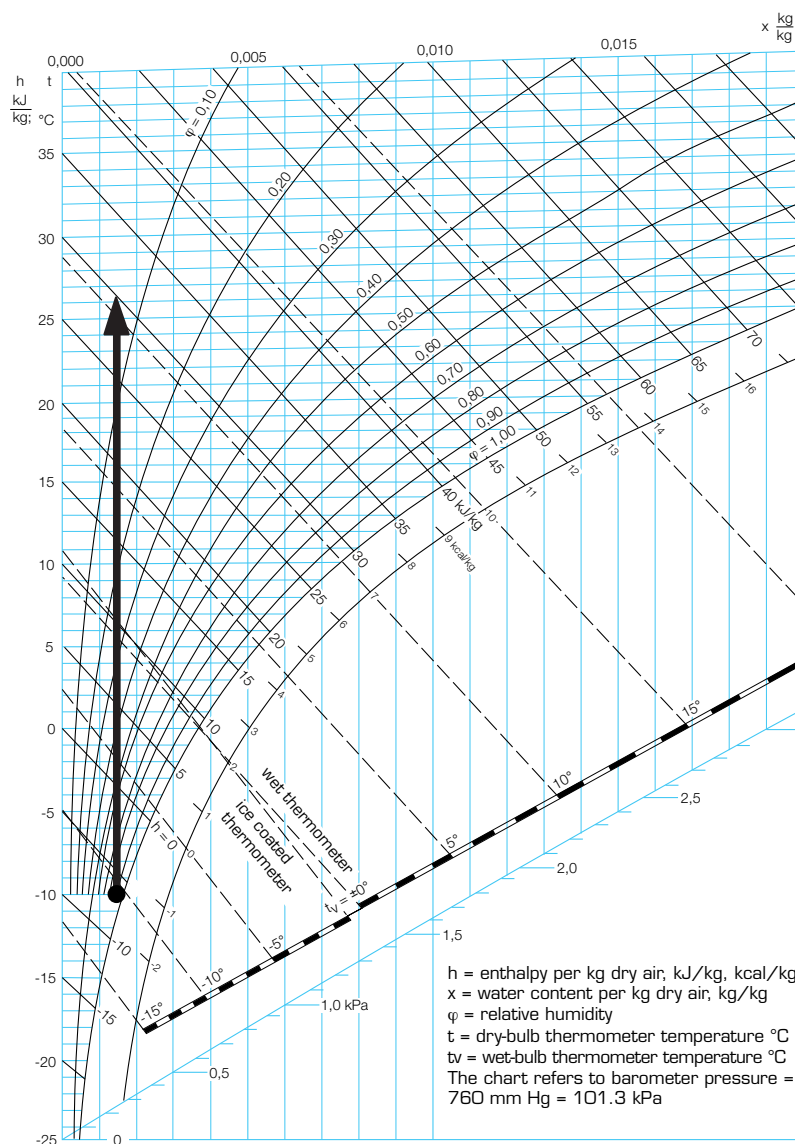

# The cooling process

In the cooling process, the air is often cooled down to below the dew point and the water condenses. The total cooling load can be easily calculated from the change in enthalpy while sensible cooling can be calculated from the change in dry-bulb thermometer temperature.

The shape of this process line can vary depending on the design of the cooling coil.

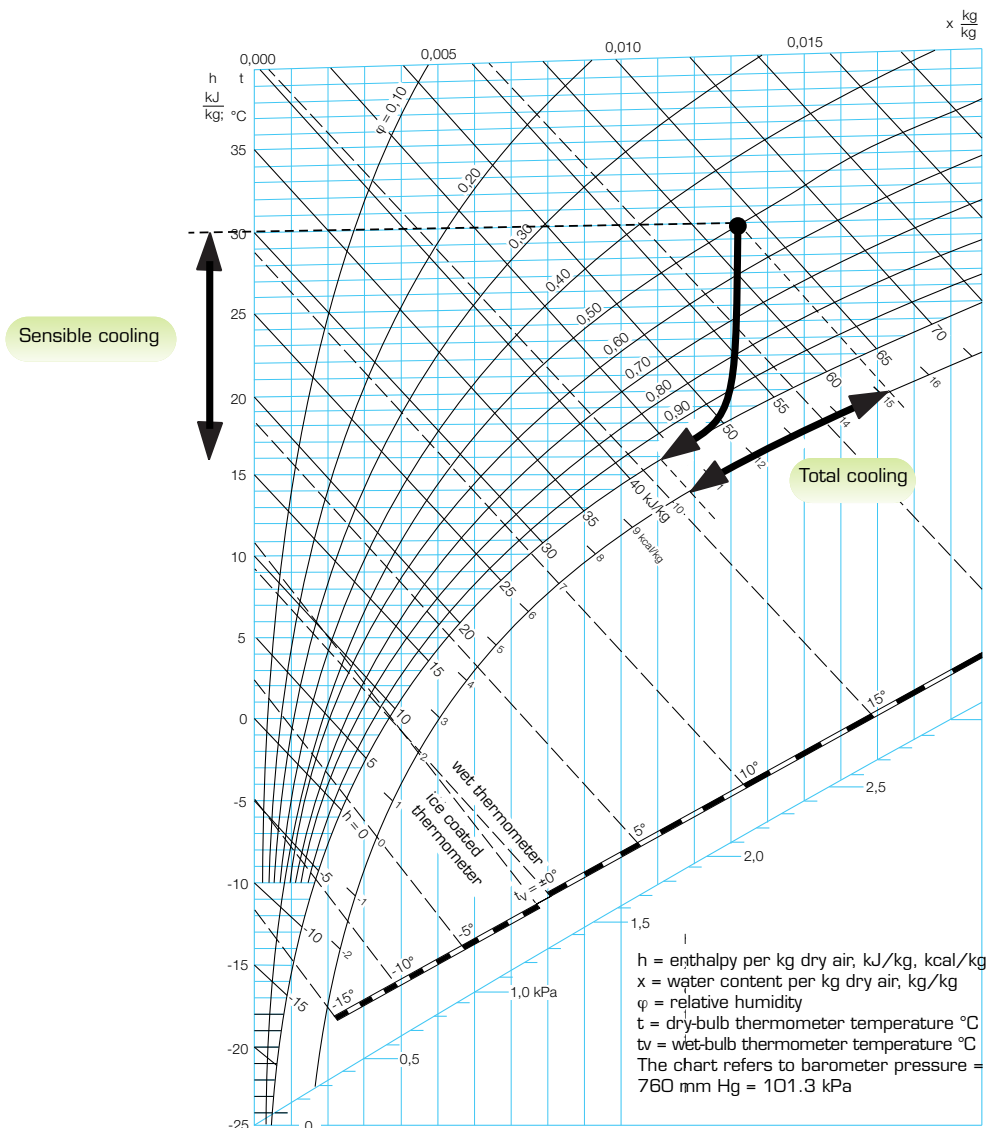

# Humidification with water or steam

Humidification is the process which increases the water content of the air. This is made possible e.g. by supplying steam or the evaporation of water.

## 1 Humidification by means of water evaporation

The heat which is essential for water evaporation extracted from the air, which in this way is cooled down. If the water is circulated in the humidifier it will soon reach the adiabatic saturation temperature. This means that the process follows the wet-bulb thermometer lines.

If the water is conveyed directly to the humidifier, the process will be influenced by the temperature of the water. Very cold water tends to cool the air more while warm water offers less cooling.

## 2 Humidification with steam

When you use steam, the direction of the process line is almost horizontal. The dry-bulb thermometer air temperature does not change very much. The consumption of steam is calculated from the difference of water content multiplied by the volumetric flow of the air.

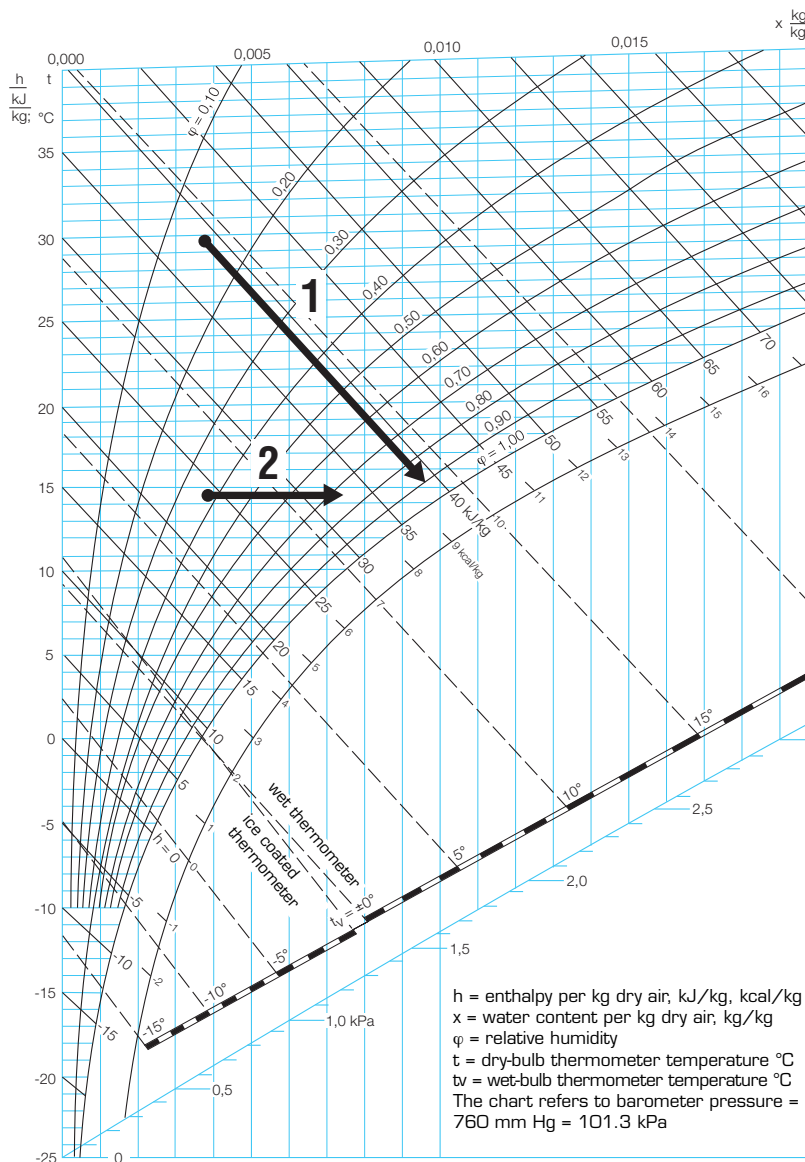

## Mixing two air flows

If two volumes of dry air  $m_1$  and  $m_2$  whose physical property corresponds to the points A1 and A2 are mixed, the mixing point (B) will be found on the straight line which connects the original points. Its real position can be determined graphically by dividing the A1 A2 line into two lengths so that  $L_1/L_2 = m_2/m_1$ .

The same result can be calculated by using absolute degrees of humidity as follows:

$$B = \frac{m_1 \cdot x_1 + m_2 \cdot x_2}{m_1 + m_2}$$

Where

$B$  = Mixing point kg/kg

$m_1$  and  $m_2$  = air volume in point 1 and 2

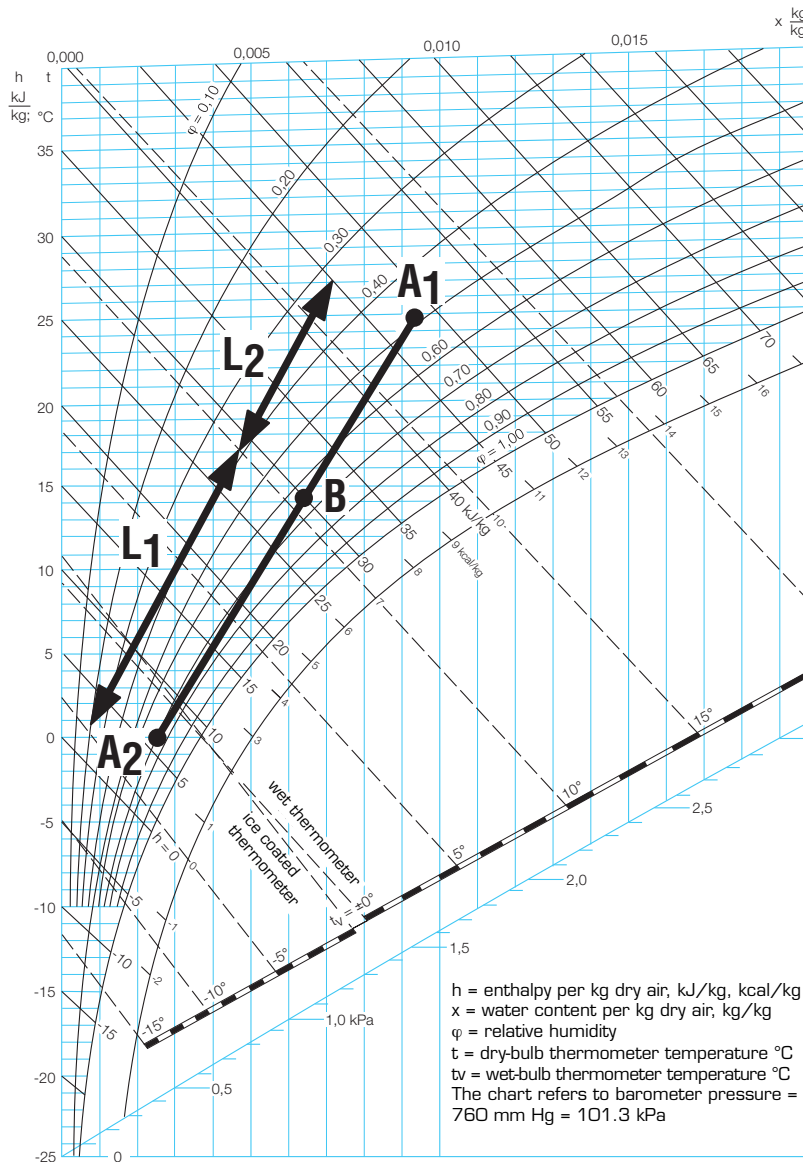

## Mixing two airflows – Mist

A mist can sometimes be caused if two non-saturated air masses are mixed. This could be the consequence if two similar air masses with properties corresponding to the points A3 and A4 are mixed. The mixture point B1 can then fall below the saturation line at which point a mist is formed.

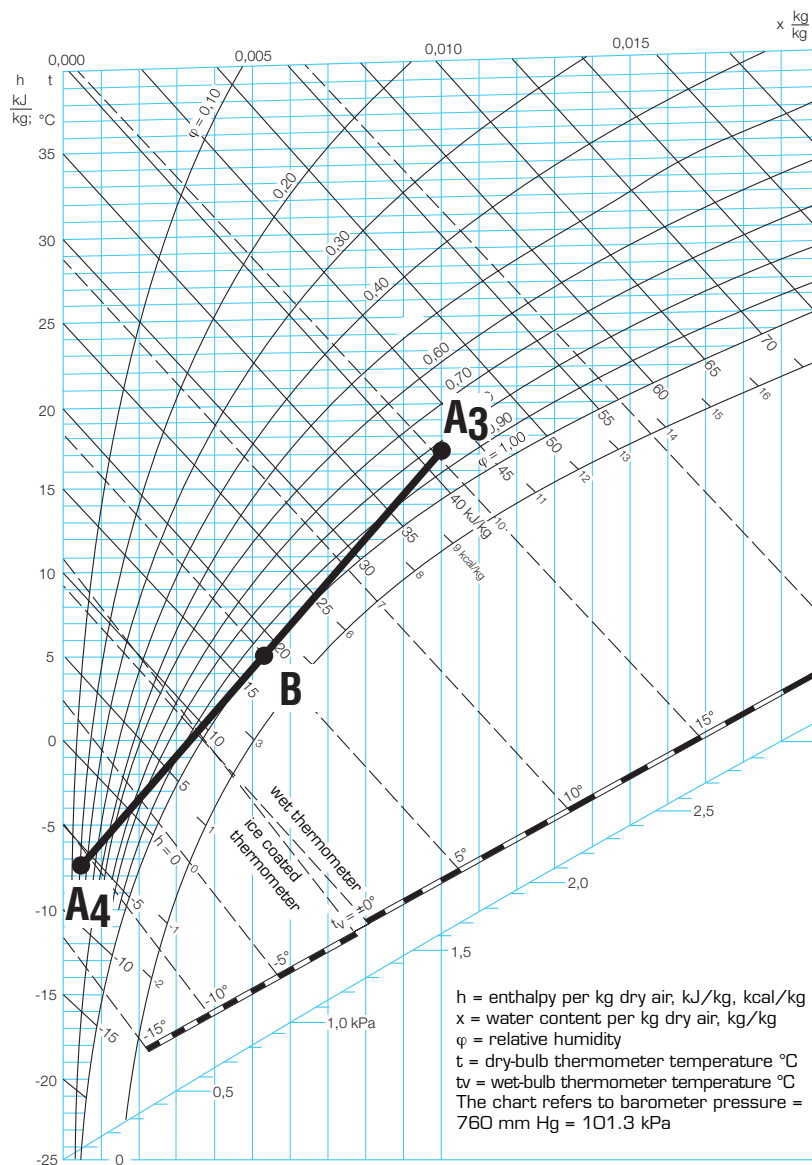

# Different climates in the Mollier Chart

The areas encircled/enclosed in green indicate where the various climates are situated in the Mollier Chart and in which area you will find the indoor climate for offices.

Warm and dry air



Warm and moist air

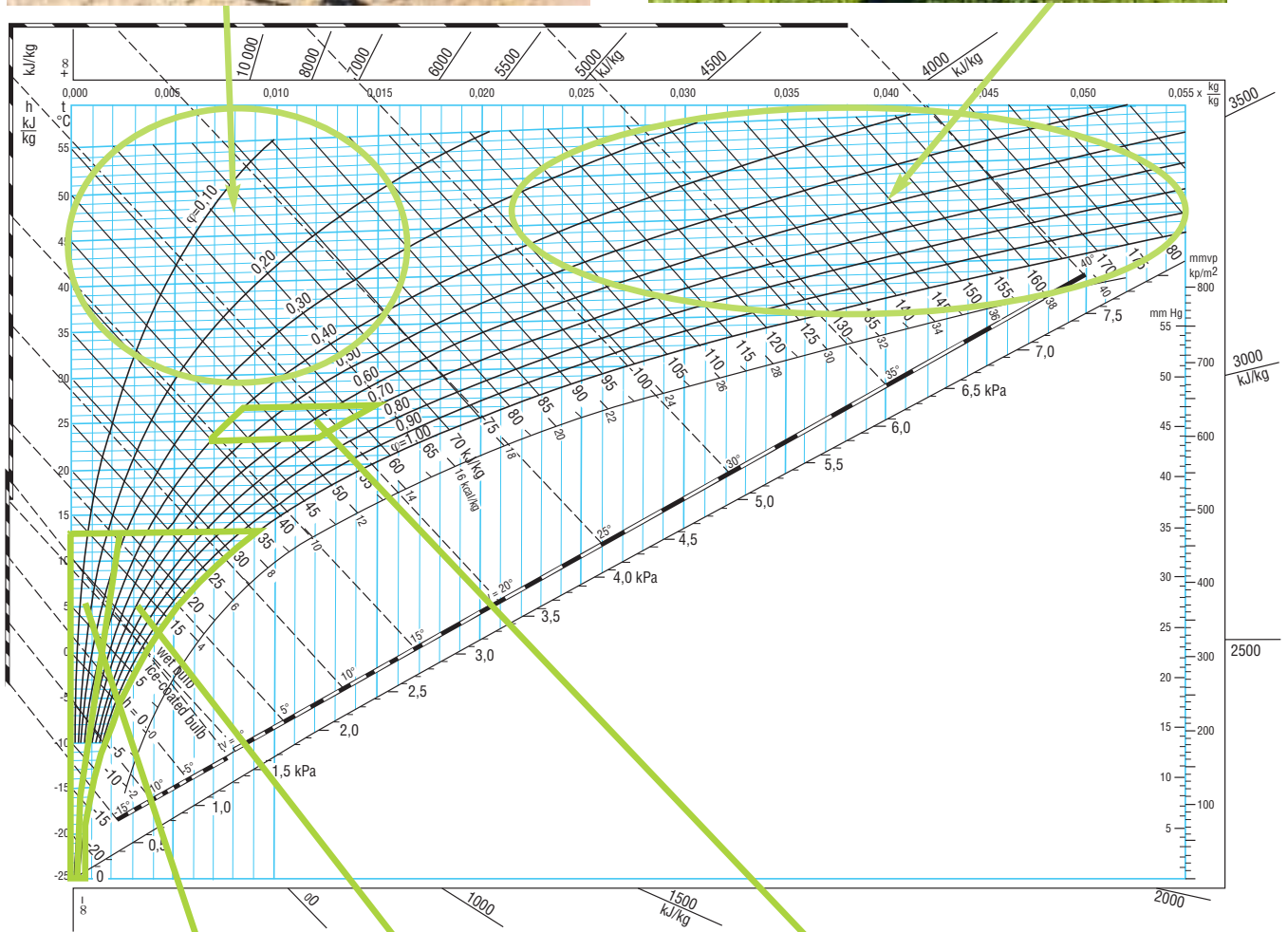

Cold and dry air



Cold and moist air



Ideal office climate:  
23-26°, 40-70% air humidity



## Summary



The outside air consists of a mixture of many gases, vapour and dust particles. In order to understand the processes taking place in air handling units we need to think of air as a mixture of dry air and water vapour, what we call moist air.

The following terms are used in order to describe the properties and the condition of air:

- Dry-bulb thermometer temperature ( $t_{db}$ ).  
The temperature which you measure with an ordinary thermometer, is specified in °C.
- Wet-bulb thermometer temperature ( $t_{wb}$ ).  
Used as a measure of the humidity in the air; specified in °C.
- Water content ( $x$ ). Describes the volume of water present in the air; specified in kg water/kg dry air.
- Enthalpy ( $h$ ). It describes the energy volume in the air compared to a reference point at

freezing temperature. Specified in kJ/kg dry air.

- Saturation is calculated by dividing the current water content in the air with the water content the air has at saturation. Specified in %.
- Relative humidity ( $\phi$ ), is calculated by dividing the pressure of the water vapour by the pressure of the water vapour when the air is saturated at the same temperature. Specified in %.

These various terms used to describe the properties of the air are given in a Mollier Chart. The Mollier Chart is used for describing air conditioning processes such as heating, cooling, dehumidifying and the mixing of air. The Mollier Chart is also used for calculating temperature, energy consumption, etc.





# 4 Fluid engineering



### The chapter deals with the following

- Laminar flow
- Turbulent flow
- Boundary layer
- Reynold's number
- Static, dynamic and total pressure
- Bernoulli's equation

Fluid engineering is important for many segments of air handling engineering. The airflow in fans, ducts, filters, coils and water flow in coils and pipes can be mentioned. The airstream conditions are also of the greatest importance for heat transfer and for the generation of noise.

The forces acting in a flow of liquid or gas are pressure forces, inertial forces and friction forces. When all the forces are of the same magnitude, theoretical calculations become complex. If one or two forces are dominant, the calculations are simplified.

Within air handling engineering, can in most cases be overlooked the inertial forces (though not in the impeller of a fan) and the flow is determined by pressure and friction forces.

## Laminar and turbulent flow

Fluid flow can be categorized in two types: When the flow velocities are low enough, the flow is in parallel layers and this is called **laminar**. At higher velocities the flow is normally characterized with swirling movements of different magnitude and frequency. Such flow is called **turbulent**.

When the flow is turbulent, the friction and heat transfer are substantially greater than when the flow is laminar. This is due to the swirl movements present in the turbulent flow. If the flow is laminar or turbulent it can strongly influence heating and cooling transfer respectively. This applies both to air and to water. When water flows in laminar layers in a pipe, this drastically reduces heat transfer and it becomes difficult to control the flow.

## Reynolds Law of Uniformity

Reynolds law of uniformity is used for determining whether the flow is laminar or turbulent.

### Reynolds number (Re)

$$Re = \frac{wL}{\nu}$$

Where

$w$  = mean velocity of the fluid in m/s

$L$  = a length that is characteristic for the body (for an air stream inside a duct  $L = d =$  the diameter of the duct in m)

$\nu$  = The kinetic viscosity of the fluid in  $m^2/s$

A consequence of Reynolds law of uniformity is that you can determine whether a certain flow is laminar or turbulent. Experiments with various geometries have shown the approximate Re- numbers,  $Re_{krit}$ , at which the air stream switches from laminar to turbulent.

This occurs at  $2300 < Re_{krit} < 4000$  inside a duct.  $500 < Re_{krit} < 1000$  applies to the flow between flat plates (flanges) with the distance between the plates as a characteristic length.

If the laminar flow is disturbed,  $Re_{krit}$  will be lower than what is stated above. The change is not very abrupt, but the transition always takes place across a change-over area.

## Definition of pressure

Three pressures can be defined in a fluid: static, dynamic and total pressure.

The static pressure is the pressure that the fluid exercises perpendicular to the direction of flow. In pipes it is measured through a small hole in the pipe wall.

The total pressure is the pressure which the medium exercises against a small surface perpendicular to the direction of flow where the medium without loss has been slowed down to zero velocity.

The dynamic pressure is the difference between total pressure and static pressure.

The figure diagrammatically shows the principle for measuring duct pressure. In this case the static pressure in the duct is greater than the atmospheric pressure.

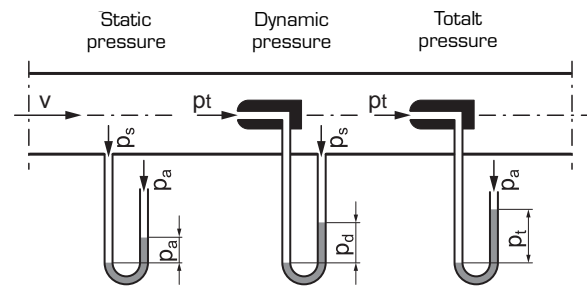

Pressure in duct and principle sketch for measuring

## Flow in pipes and ducts

### Bernoulli's simplified equation

If we assume that the flow is incompressible and friction free and also overlook differences in height, we have come to the simplest version of Bernoulli's equation.

$$\frac{p_s}{\rho} + \frac{1}{2} \cdot v^2 = \text{constant}$$

Where

$p_s$  = static pressure, Pa

$\rho$  = density, kg/m<sup>3</sup>

$v$  = air velocity, m/s

If the formula above is multiplied by the density, we will have the following equation.

$$p_s + \frac{\rho}{2} \cdot v^2 = p_s + p_d = p_t = \text{constant}$$

Where

$p_s$  = static pressure, Pa

$\rho$  = density, kg/m<sup>3</sup>

$v$  = air velocity, m/s

$p_d$  = dynamic pressure, Pa

$p_t$  = total pressure, Pa

Bernoulli's equation mathematically describes the phenomenon that an increase in velocity gives rise to a decrease in static pressure and also vice versa a decrease of velocity gives rise to an increase in static pressure.

### Pressure losses caused by friction

Pressure losses can be caused by friction which arises between the duct walls and the air. The following formula is used for calculating the loss in pressure:

$$\Delta p_\lambda = \lambda \cdot \frac{L}{d} \cdot \frac{\rho}{2} \cdot v^2$$

Where

$\Delta p_\lambda$  = Pressure losses caused by friction

$d$  = duct diameter, m

$L$  = duct length, m

$v$  = air velocity, m/s

$\rho$  = the density, kg/m<sup>3</sup>

$\lambda$  = friction factor owing to Reynold's number or the surface coarseness of the duct wall

In order to calculate the friction factor ( $\lambda$ ) the following formulas are used:

**For laminar flow (Re ≤ 2320):**

$$\lambda = \frac{64}{Re}$$

**For turbulent flow (Re ≥ 2320):**

$$\frac{1}{\sqrt{\lambda}} = 1,14 - 2 \log \cdot \frac{k}{d}$$

Where

$k$  = the surface coarseness of the duct wall, mm

$d$  = the duct diameter, m

### Pressure losses caused by duct changes

Pressure losses, non-recurring losses, arise when e.g. sudden area changes in the duct, in pipe bends, etc.

The following formula is used for calculating the loss in pressure:

$$\Delta p_f = \zeta \cdot \frac{\rho}{2} \cdot v^2$$

Where

$\Delta p_f$  = Pressure losses caused by duct changes

$\zeta$  = the non-recurrent loss coefficient

$\rho$  = the density, kg/m<sup>3</sup>

$v$  = air velocity, m/s

### Bernoulli's extended equation

When we consider the pressure losses described in earlier chapter and differences in height as well, we find it useful to apply Bernoulli's extended equation.

$$p_1 + \frac{\rho \cdot v_1^2}{2} + \rho g h_1 = p_2 + \frac{\rho \cdot v_2^2}{2} + \rho g h_2 + \Delta p_\lambda$$

Where

$p$  = static pressure referred to the height level  $h = 0$ , Pa

$\rho$  = density, kg/m<sup>3</sup>

$v$  = air velocity, m/s

$g$  = acceleration due to gravity, m/s<sup>2</sup>

$h$  = height, m

$\Delta p_\lambda$  = pressure losses, Pa

$\frac{\rho \cdot v^2}{2}$  = Dynamic pressure

$\rho g h$  = Elevation pressure

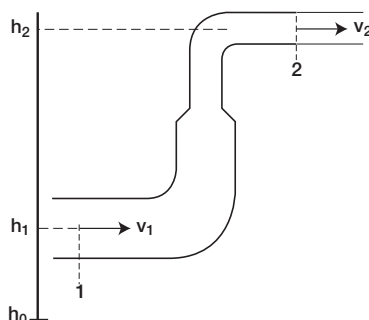

The non-recurrent loss coefficient,  $\zeta$ , is given below for a few different cases.

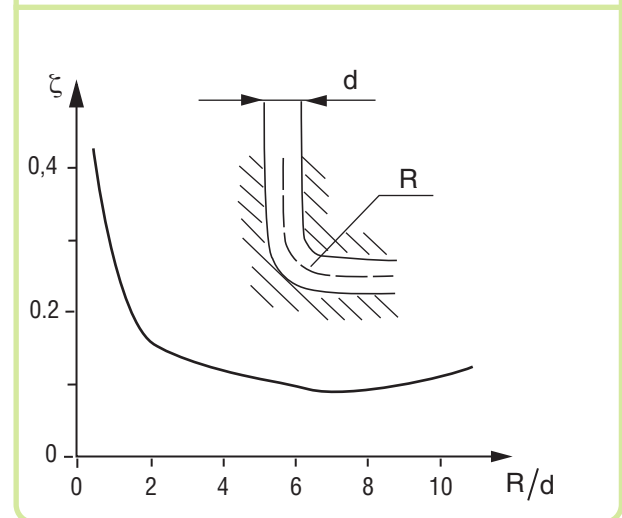
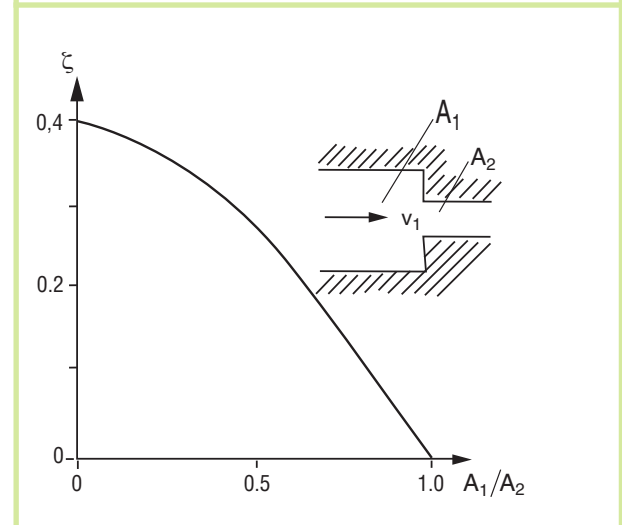
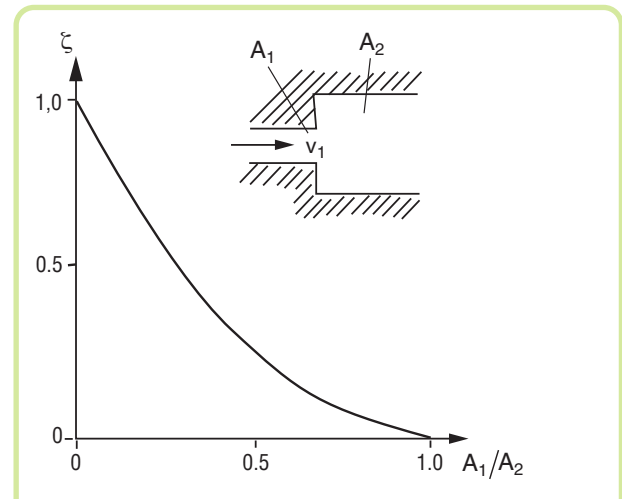

### Pressure drop data for a circular duct system

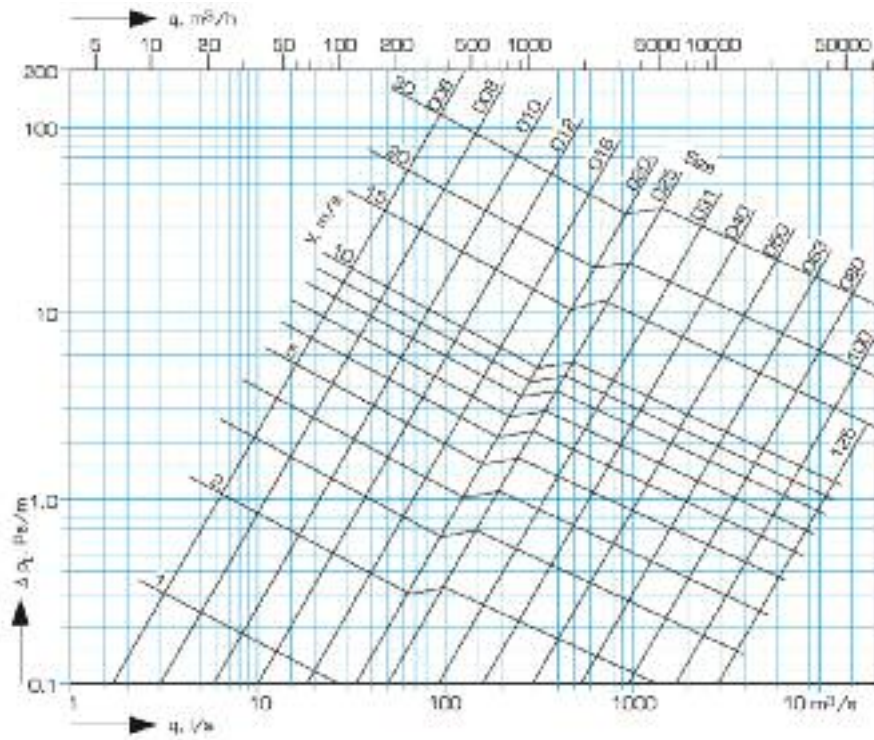

### Pressure drop data for a rectangular duct system

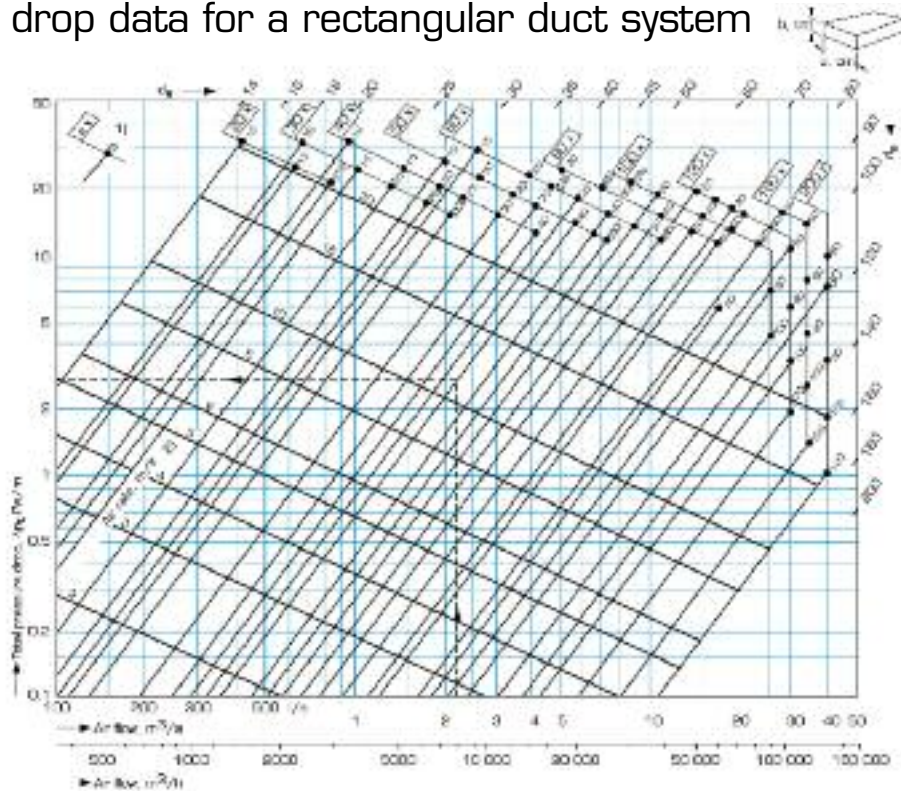

## Summary



The forces acting in a liquid or in a gas are pressure forces, mass forces and friction forces.

In air handling engineering, the mass forces can in most cases be ignored (though not in the impeller) and the flow is determined by pressure and friction forces.

Fluid engineering is basic for many segments of air handling engineering.

The air flow in fans, ducts, filters, coils and the water flow in coils and pipes can be mentioned.

There are two types of flow: laminar and turbulent. Whether the flow is laminar or turbulent can have a strong influence on heating and transfer respectively. This applies both to air and water.

When there is a laminar flow of water in a pipe, this substantially reduces heat transfer performance and the flow becomes difficult.

Reynolds law of uniformity is used for determining whether the flow is laminar or turbulent.

Three different types of pressure in a flow can be defined: static, dynamic and total pressure.

These pressures can be calculated by applying Bernoulli's equation.

Bernoulli's equation also describes that an increase in velocity gives rise to a decrease in static pressure and vice versa that a decrease in velocity gives rise to an increase in static pressure.

# 5 Heat transfer



### The chapter deals with the following

- Heat conduction
- Fourier's Law
- Convection
- Radiation
- Classification of an air handling unit's thermal insulation

Heat is a form of energy that is always transferred from the warm to the cold part of a substance, or from one body with high temperature to a body with lower temperature.

In air treatment engineering, there are a number of areas in which knowledge about heat transfer is important.

We can mention coils, heat recovery systems, cooling processes and heat transport through walls. In coils and heat exchangers, we want material with high thermal conductivity and a high degree of convection between the body and the liquid/gas.

In other applications, we want good thermal insulation and the thermal conductivity and convection should then be minimized.

Heat can be transferred in three different ways: through conduction, convection and radiation.

## Heat conduction

Heat conduction is a process in which the energy exchange occurs by means of electron movements in metals or for liquid/gas at rest by means of molecular movements. The flow of heat per surface unit can be expressed using Fourier's Law.

$$q = -\lambda \cdot \frac{dt}{dn} \quad [W/m^2]$$

Where

$\lambda$  is the thermal conductivity of the material  
 $\frac{dt}{dn}$  is the temperature gradient in the direction of the surface roughness standard.

The minus sign is motivated by the fact that heat always moves from one area with higher temperature to an area with lower temperature.

For a plane wall it can be shown that:

$$q = -\lambda \cdot \frac{dt}{dy} = -\lambda \cdot \frac{(t_2 - t_1)}{\delta} = \lambda \cdot \frac{(t_1 - t_2)}{\delta} \quad [W/m^2]$$

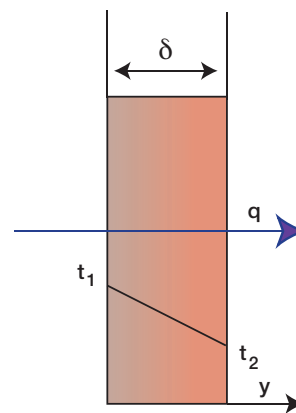

For a circular pipe:

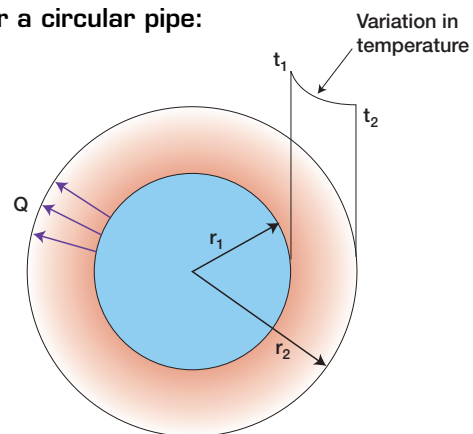

$$Q = -2\pi \cdot r \cdot \lambda \cdot \frac{dt}{dr} \quad [W]$$

However, when  $Q$  is independent of  $r$ , on integration we obtain the heat flow per unit length to:

$$Q = -2\pi \cdot \lambda \cdot \frac{t_2 - t_1}{\ln \frac{r_2}{r_1}} \quad [W]$$



## Convection

Convective heat transfer implies that bodies are heated or cooled by a surrounding fluid in motion. In the fluid, heat transport takes place through a combination of molecular heat conduction and the fluid's macroscopic movements. At the surface of the body, it is important that the velocity of the fluid is zero which is why heat transfer only occurs by means of heat conduction.

If movement in the fluid is achieved by external devices such as fans, pumps, etc., we speak of forced convection. If the movements in the fluid arise as a consequence of variations in density (due to temperature difference), then we have natural convection.

## Radiation

Heat exchange through thermal radiation requires no medium in order to propagate. It can arise between two surfaces or between surface and gas. It can also be an interaction between several surfaces and gases.

The heat exchange through radiation is almost always negligible if the temperatures are about room temperature compared to the exchange through convection.

## Classification

The CEN standard EN 1886 classifies the air handling unit casing on the basis of its thermal insulating property in two ways.

Partly through the coefficient of thermal conductance  $U$  ( $W/m^2 \text{ } ^\circ C$ ) in the classes T1 to T5, and partly through the insulation coefficient  $K_b$ . This indicates the air handling unit's capability to resist the formation of condensation TB1 to TB5.

The coefficient of thermal conductance,  $U$ , is determined by measuring the stationary heat loss for a temperature difference of  $20 \text{ } ^\circ C$  between the temperature inside the air handling unit and outside it. The coefficient of thermal conductance is classified according to the following table.

<b>Class T1:</b>	$0 < U \leq 0.5$
<b>Class T2:</b>	$0.5 < U \leq 1.0$
<b>Class T3:</b>	$1.0 < U \leq 1.4$
<b>Class T4:</b>	$1.4 < U \leq 2.0$
<b>Class T5:</b>	No requirements

A casing section's ability to resist condensation precipitation is classified by means of the insulation coefficient  $k_b$ . This is a dimensionless unit and is defined as follows:

$$k_b = \frac{(t_s - t_i)}{(t_e - t_i)}$$

Where

$k_b$  = Insulation coefficient

$t_i$  = The temperature of the air inside the air handling unit

$t_e$  = The temperature in the surroundings

$t_s$  = The unit sections lowest surface temperature

CEN classifies the insulation coefficient according to the following table.

<b>Class TB1:</b>	$0.75 < k_b \leq 1.00$
<b>Class TB2:</b>	$0.60 < k_b \leq 0.75$
<b>Class TB3:</b>	$0.45 < k_b \leq 0.60$
<b>Class TB4:</b>	$0.30 < k_b \leq 0.45$
<b>Class TB5:</b>	No requirements

The casing section that has the lowest insulation coefficient determines which insulation class is applicable to the air handling unit.

## Summary



Heat is a form of energy that is always transferred from the warm to the cold part of a substance, or from one body with high temperature to a body with lower temperature.

**Heat can be transferred in three different ways:**

- **By conduction**

Heat conduction is a process in which the energy exchange occurs by means of movements of electrons in metals or for liquid / gas at rest by means of molecular movements.

- **By convection**

Convective heat transfer implies that bodies are heated or cooled by a surrounding liquid / gas in motion.

- **By radiation**

Heat exchange by means of thermal radiation requires no medium in order to propagate. It can arise between two surfaces or between surface and gas. It can also be an interaction between several surfaces and gases.

### **Classification**

To determine the thermal insulation of an air handling unit, the unit can be classified based on heat loss through the casing and its condensation-proof insulation.

The unit casing is classified to CEN Standard based on heat losses T1-T5 and condensation-proof insulation classes TB1-TB5.

# 6 Cooling processes



The chapter deals with the following

- General prerequisites
- The cooling circuit
- Cooling capacity
- Energy consumption
- The coefficient of performance for cooling
- The coefficient of performance for heating



Cooler

In order to understand the cooling process we must understand how a medium acts in response to various pressures and temperatures. In order to understand this we use water as an example, but a refrigerant acts precisely in the same way.

If heat is added to water, the water will of course become warmer. But if heat is added to water, which is 100°C, the water will begin to evaporate and in the end it will completely transform to steam. The heat energy added, making 100°C water become a hundred degree steam, is called evaporation (steam-generating) heat.

If the phase transfer instead goes from steam to water, the same amount of heat energy is instead emitted.

The boiling point of the water also changes depending of the surrounding pressure. For example, the boiling point for water 3000 metres above sea level is just below 90° C. This is because the atmospheric pressure becomes lower at higher altitudes. In the same manner, the boiling point rises with rising pressure. The boiling point in a pressure cooker is usually approx. 110°C. This is because that the pressure in the pressure cooker is approx. 50% higher than normal atmospheric pressure.



Chiller

A cooling process utilizes pressure changes in order to make evaporation and condensation temperatures occur at different temperatures. The process can either be utilized to cool down air directly (so called dx-cooling) or cool down water, which then is used to cool down air.

# The cooling process

The cooling process consists of four main processes. After one cycle finishes, the next one begins:

1. The pressure is low in the evaporator, which causes the refrigerant to boil at a low temperature and the liquid transforms to gas. In order to utilize this process, heat is taken from the supply air, which this way is cooled down.
2. The gas enters the compressor where it is compressed to a higher pressure. This raises the temperature.
3. When the gas enters the condenser, the pressure is so high that the refrigerant condenses in spite of the high temperature and all gas is transferred to liquid. In order for this to take place, heat must be emitted to the extract air.
4. The pressure in the expansion valve drops and this also lowers the temperature of the liquid.

There are three different areas in the chart. The areas differ from each other by the saturation line, which in the chart below is shown as a fat line.

The area to the left of the saturation line represents pure liquid; the area within the curve represents a blend of liquid and gas and the area to the right represents pure gas. All the phase transformations, evaporation and condensation, occur under constant temperature within the line.

A temperature curve has been plotted, which vertically enters the liquid phase, horizontally is within the curve and bends downward into the steam phase. There are lines with constant entropy which describe the perfect compression in the steam phase. Because of losses, the compression does not entirely follow these lines (see chart). CP is the critical point.

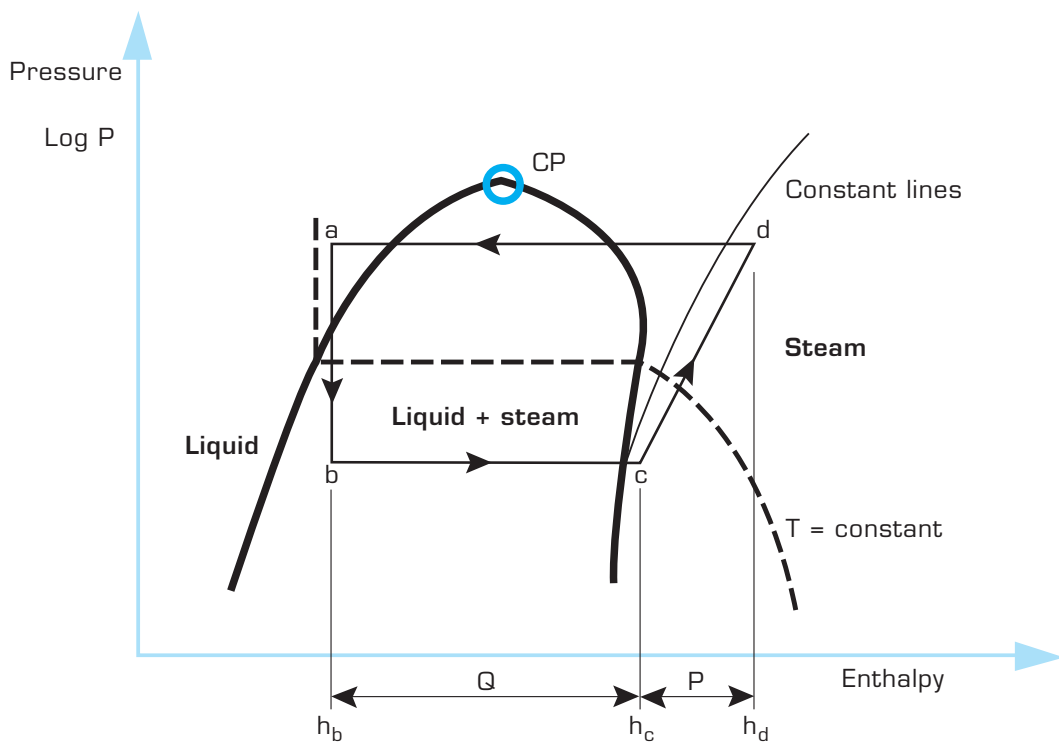

h-log P diagram

## Cooling capacity

The cooling capacity is given as the change in enthalpy in the evaporator multiplied by the flow velocity of the refrigerant mass.

$$Q = m \cdot (h_c - h_b)$$

Where

$Q$  = Cooling capacity kW

$m$  = the mass flow kg/s of the refrigerant

$h_c - h_b$  = change in enthalpy from b to c,  
see the chart on preceding page

## Energy consumption

The cooling circuit is driven by the compressor and the energy consumption is given by the enthalpy change in the compressor multiplied by the flow velocity of the refrigerant.

$$P = m \cdot (h_d - h_c)$$

Where

$P$  = Power required, kW

$m$  = The mass flow of the refrigerant

$(h_d - h_c)$  = change in enthalpy from c to d,  
see the chart on preceding page

## The coefficient of performance for cooling

The coefficient of performance for cooling (COP<sub>2</sub>) is defined as heat which enters into the evaporator divided by work performed by the compressor.

$$COP_2 = \frac{Q}{P} = \frac{m \cdot (h_c - h_b)}{\dot{m} \cdot (h_d - h_c)}$$

Where

$COP_2$  = Coefficient of performance for cooling

$Q$  = Cooling capacity kW

$P$  = Power required, kW

We see that COP is a measurement of the design of the cooling unit and that it is not subordinate to the mass flow of the refrigerant.

$$COP_2 = \frac{(h_c - h_b)}{(h_d - h_c)}$$

## Coefficient of performance for heating

The coefficient of performance for heating (COP<sub>1</sub>) is defined as the heat which is removed in the condenser divided by the work performed by the compressor.

$$COP_1 = \frac{(h_d - h_a)}{(h_d - h_c)}$$

Since  $(h_d - h_a) = (h_c - h_b) + (h_d - h_c)$

it follows that  $COP_1 = COP_2 + 1$

## Summary



In order to understand the cooling process we must understand how a medium acts in response to various pressures and temperatures. In order to understand this we use water as an example, but a refrigerant acts precisely in the same way.

If heat is added to water the water will of course become warmer. But if heat is added to water which is 100°C, the water will begin to evaporate and in the end fully transform to steam. The heat energy added to make 100°C water become steam of a hundred degree is called evaporation heat.

If the phase transfer instead goes from steam to water, the same amount of heat energy is instead emitted. It is also very important to know that the boiling point of the water is changed depending of the surrounding pressure. For example, the boiling point for water 3000 meter above sea level is just below 90°C. This is because the atmospheric pressure becomes lower the higher up we are. In the same way the boiling point is raised with rising pressure. The boiling point in a pressure cooker is usually approx. 110°C. This is because the pressure in the pressure cooker is approx. 50 % higher than normal atmospheric pressure.

A cooling process utilizes pressure changes in order to make evaporation and condensation temperatures occur at different temperatures.

The process can either be utilized to cool down air directly (so called dx-cooling) or cool down water which then is utilized to cool down air.

**The cooling process consists of four main processes. After one cycle finishes, the next one begins:**

1. The pressure is low in the evaporator, which causes the refrigerant to boil at a low temperature and the liquid transforms to gas. In order to utilize this process, heat is taken from the supply air, which this way is cooled down.
2. The gas enters the compressor where it is compressed to a higher pressure. This raises the temperature.
3. When the gas enters the condenser, the pressure is so high that the refrigerant condenses in spite of the high temperature and all gas is transferred to liquid. In order for this to take place, heat must be emitted to the extract air.
4. The pressure in the expansion valve drops and this also lowers the temperature of the liquid.

The process is normally drawn in an h-log P diagram, where h is the enthalpy, the energy content in a substance, and P is the pressure of the refrigerant.





# Heat and cooling energy recovery





The chapter deals with the following

- Duration chart
- Efficiency

Heat recovery used in comfort ventilation systems is always very profitable. In a cool climate the pay-back period can be as short as one year. In a hot climate, the pay-back period can also be very short because a smaller size of cooling unit can be used, thus lowering the initial investment cost and reduces the energy consumption.

How large the savings will be depends mainly on the climate at the location, the number of hours in operation and the efficiency of the energy recovery system selected.

Besides good profitability, heat and cooling energy recovery has a positive influence on the environment. Its use contributes toward improving the outdoor environment in that it reduces the need for burning fuel and this in turn reduces carbon dioxide emissions, for instance.

A higher rate of air change can also be motivated when the energy consumption is low, which has a positive influence on the air quality in the building. Because heat transfer is a function of temperature difference, a characteristic of recovery units is that the colder the outdoor air is the more heat can be recovered from the extract air. In the same manner you recover more cooling energy the warmer the outdoor air is. The exception is in the event of really low outdoor temperatures when the moisture content of the extract air can give rise to frosting in the heat exchanger. The heat exchanger must then be regulated to reduce the heat transfer, or run through a recurring defrosting cycle.

There are a number of different heat recovery systems on the market each with its own set of advantages and disadvantages depending on application.

## Duration chart

To calculate the benefit of heat recovery we need to consider a full year of operation and not just the peak demand.

The chart to the right shows a duration degree-hour chart. It shows the duration of temperature in Stockholm during an average year. The different surfaces denote the number of degree hours, degrees times hours which multiplied by air flow ( $q$ ), density ( $\rho$ ) and specific heat ( $c_p$ ) give a heating or cooling capacity demand.

The lower surface between outdoor temperature and supply air temperature shows the annual heating capacity demand,  $Q_{tot}$ , without heat exchanger and for continued operation.

$$Q_{tot} = q \cdot \rho \cdot c_p \cdot \text{the number of degree hours}$$

Where

$Q_{tot}$  = the annual heating demand, kWh/year without heat exchanger

$q$  = air flow  $m^3/s$

$\rho$  = density  $kg/m^3$

$c_p$  = specific heat,  $J/kg \cdot ^\circ C$

The demand for additional heating,  $Q_{rest}$ , is shown in the small corner at the upper left in the chart.

$$Q_{rest} = \left( 1 - \frac{\eta_{\text{mean annual year}}}{100} \right) \cdot Q_{tot}$$

Where

$Q_{rest}$  = the annual heating demand, kWh/year with heat exchanger

$\eta_{\text{mean annual year}}$  = the mean annual efficiency for the heat exchanger, %

$Q_{tot}$  = the mean annual heating demand, kWh/year without heat exchanger

The mean annual efficiency will be higher than the efficiency specified by the manufacturer, when the extract air normally is warmer than desired supply air. If an efficient heat exchanger is used, the mean annual efficiency can amount to 85-95 %.

If the running time is shorter than 100% (continuous operation) the heating load can often with sufficiently good accuracy be reduced by the same factor as the running time. For accurate measurements, it should be taken into consideration that the day and night duration curves differ slightly from the mean value curve. When calculating energy values based on the duration chart, as in the figure to the right, note that the effect of moisture in the air, so-called latent energy, has been left out.

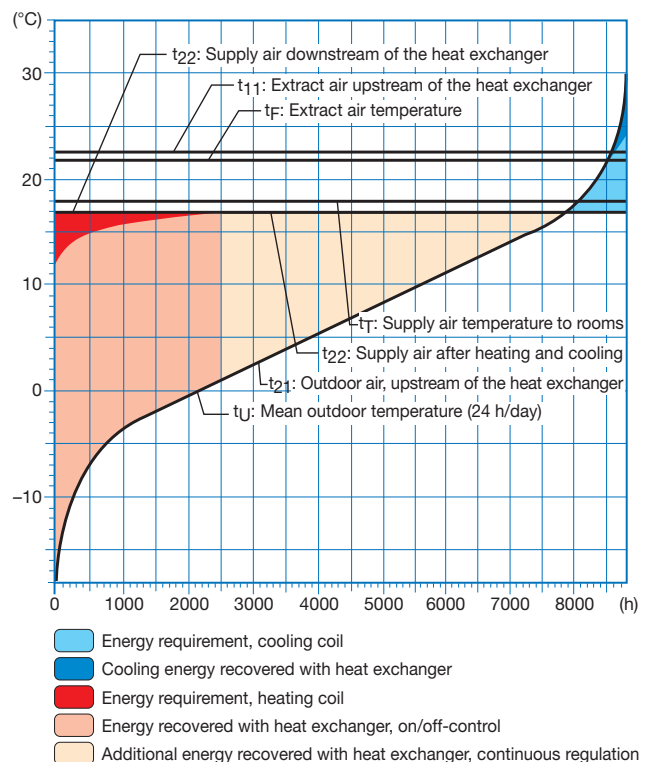

Efficiency chart

## Definitions

The figure below shows the principle of heat recovery, in this example a rotary heat exchanger. Extract air is conveyed through the heat exchanger and leaves it as exhaust air. The outdoor air absorbs heat from the extract air and leaves the heat exchanger as supply air.

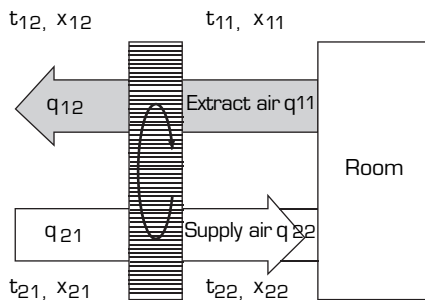

Temperature efficiency

$$\eta_t = \frac{t_{22} - t_{21}}{t_{11} - t_{21}} \cdot 100$$

Moisture efficiency

$$\eta_x = \frac{x_{22} - x_{21}}{x_{11} - x_{21}} \cdot 100$$

Symbols used

- q = Air flow m<sup>3</sup>/s
- t = Temperature °C
- φ = Relative humidity in the air %
- η<sub>t</sub> = Temperature efficiency, %
- η<sub>x</sub> = Moisture efficiency, %
- x = Moisture content kg/kg

Index

- 1 = extract air side
- 2 = supply air side
- 11 = extract air, inlet
- 12 = extract air, outlet
- 21 = supply air, inlet
- 22 = supply air, outlet

## Efficiency

The efficiency is a measurement of the capacity of the heat exchanger and is given as a percentage of theoretical recovery, which is the case where the supply air should reach the same temperature and moisture content as the extract air (efficiency of 100%).

The temperature efficiency indicates how the temperature across the heat exchanger changes (sensible energy) and the moisture efficiency indicates how the moisture content changes (latent energy).

Both the efficiencies are dimensionless numbers. This implies that even if they are measured during two given conditions (heat and cooling energy recovery respectively), based on very variable outdoor temperatures they can be used in each case for calculating what supply air temperature can be obtained. A given heat exchanger will have lower efficiency the higher the air flow is. The efficiency also decreases as the ratio between the outdoor air flow and the extract air flow increases.

The following characteristics are decisive for the efficiency of a heat exchanger:

- The flow conditions inside the heat exchanger; Parallel flow – Counter flow – Cross flow
- Heat transfer units,  $N_{tu}$
- Whether heat transfer takes place directly air-to-air or via liquid coupling.

From the chart we can see that the efficiency increases when the number of heat transfer units  $N_{tu}$  increases. In order to increase the number of heat transfer units, you can see from the formula that  $\alpha$  and  $F$  must increase or else  $C_{min}$  must decrease. You can increase the heat transfer surface,  $F$ , by making the foil spacing tighter. The disadvantage with narrower the foil spacing is that it increases the pressure drop. The surface coefficient of the heat transfer,  $\alpha$ , increases if the air flow is turbulent, but this is very hard to achieve in a heat exchanger. The efficiency also increases when air flows at low velocity through the heat exchanger, which we see in the formula for  $C_{min}$ .

Heat transfer units are expressed as:

$$N_{tu} = \frac{\alpha \cdot F}{C_{min}}$$

$$C_{min} = q_{min} \cdot \rho \cdot cp$$

Where

$N_{tu}$  = the number of heat transfer units

$\alpha$  = surface coefficient of the heat transfer  $W/m^2 \text{ } ^\circ C$

$F$  = heat transfer surface, one side  $m^2$

$\rho$  = density  $kg/m^3$

$q_{min}$  = the lowest flow  $m^3/s$

$cp$  = specific thermal capacity

A heat exchanger that operates in a counter flow configuration has higher efficiency than those that operate in a cross flow or a parallel flow configuration.

The figure below shows the principal efficiency as a function of  $N_{tu}$ .

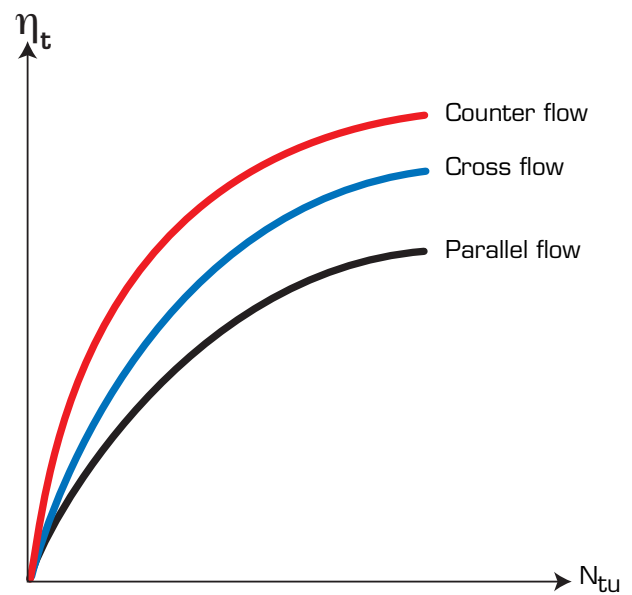

The efficiency as function of number of heat transfer units.

## Summary



Heat and cooling energy recovery involves savings, seen both from an economical and an environmental perspective.

### Duration chart

Duration charts indicate the duration of the outdoor temperature for a specific location during a mean annual year. From the chart you can read the mean annual heating load.  $Q_{tot}$  without heat exchanger for continuous operation and the load when you have an efficient heat exchanger,  $Q_{rest}$ .

### Efficiency

Efficiency is a measurement of capacity with regard to energy consumption and is specified in %.

Decisive for the efficiency of a heat exchanger is:

- The flow conditions inside the heat exchanger;  
Parallel flow – Counter flow – Cross flow
- The number of heat transfer units,  $N_{tu}$
- Whether heat transfer takes place directly air-to-air or via liquid coupling.

# LCC and energy calculations

8



### The chapter deals with the following

- Energy efficiency is the most important parameter
- Life cycle cost (LCC)
- Life cycle energy cost,  $LCC_E$
- Energy cost and  $CO_2$  emission
- Minimizing the energy cost
- Parameters for energy and  $LCC_E$  calculation

Studies show that the cost of operating an air handling unit throughout its useful product life is greater than the cost of the initial purchase itself. In certain cases, the operating costs might be 90 percent and the investment cost less than 10 percent of the total life cycle cost over a period of 20 years. In step with increasing energy costs, it is becoming more and more important to look at the whole useful life of a product, instead of merely the investment itself. The environmental debate of today, which among other things, deals with global heating, ozone depletion, spreading deserts, Kyoto Protocol has made the interest in energy efficiency of global interest. This makes it all the more important to calculate the life cycle cost of an items of equipment that consume energy, and this, among other things, includes air handling units.

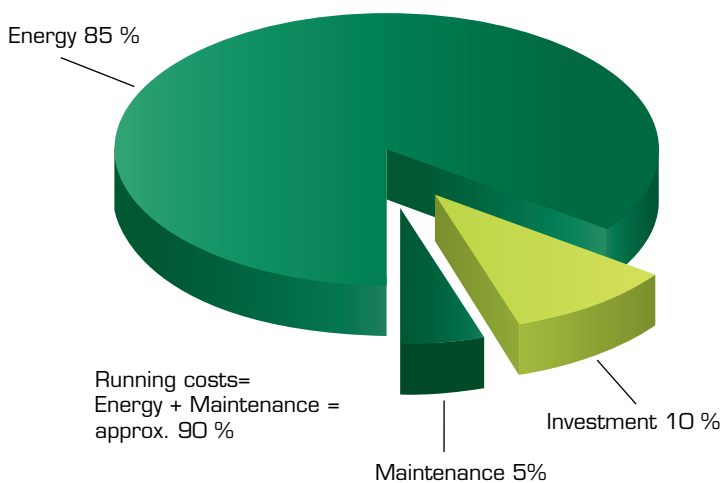

The life cycle cost for an air handling unit

### The Life Cycle Cost (LCC)

The life cycle cost (LCC) is the sum of all the costs related to a product during its useful product life. The calculation is based on the present value method, i.e. all future costs are converted to what their monetary value is today.

The life cycle cost is calculated by adding the investment costs for equipment and the present value of energy, maintenance and the environment costs during the useful life of the equipment to a present day value.

$$LCC = \text{Basic investment} + LCC_{\text{energy}} + LCC_{\text{maintenance}} + LCC_{\text{environment}} - \text{recycling value}$$

### The life cycle energy cost, $LCC_E$

The largest part of the total costs for an air handling unit involves the energy costs. More and more frequently, demands on a specific  $LCC_E$ -cost of a ventilation system are put forward and the suppliers should be able to guarantee that this cost is correct. Because of such demands, Fläkt Woods has adopted an  $LCC_E$ -module in our product selection program, where different unit functions and solutions can be compared and optimised for the lowest possible  $LCC_E$ -cost.

### Energy cost and $CO_2$ -emission

The energy cost of an air handling unit consists of two parts, the electric energy consumed for operating fans and motors and the production of thermal energy. Thermal energy can be divided up into heating and cooling energy. In northern Europe it is heating energy that constitutes the larger part of the total energy demand. A large part of the cost for heating energy can be reduced by using a heat exchanger. The cost for producing cooling energy is a post which will become larger in the future. In Central and Southern Europe, cooling is already today a large part of the total energy consumption. The result of this trend is that cooling recovery is also becoming all the more interesting.





In certain cases the client is also interested in finding out what the CO<sub>2</sub>-emissions of the unit will be. In order to calculate the energy consumption of the unit converted into CO<sub>2</sub>-emissions, we can base our calculation on CO<sub>2</sub> emissions per kWh released in the atmosphere in the production of energy for heating, cooling and electrical power.

## Minimizing the energy cost

It is of utmost importance to employ the correct prerequisites when calculating the energy costs in order to obtain a result that is reliable.

The following considerations have an essential influence on the end result:

- The lowest investment cost/ the smallest air handling unit is seldom the same as the lowest LCC<sub>E</sub>. Studies show that a larger unit often has a very short payback period, the pressure drops in the unit are lower and energy recovery is better.
- Economically optimised duct system - the lower the pressure drop in the duct system, the lower the amount of electric power consumed by the fans.
- Selection of the correct fan with correct flow, pressure and drive apparatus for each task.
- Optimised heat exchanger - correct type of heat exchanger based on prerequisites and optimised heat recovery efficiency. Maximum heat recovery efficiency is not always the best solution since larger heat exchangers also increase the pressure losses in the unit, and this increases the amount of electric power consumed by the fans.
- It is becoming more and more important to select a heat exchanger that is also optimised for recovering cooling recovery.
- If it is possible to utilize a VAV system, ventilate the building according to needs.
- Utilize the unit for its correct function. In an office building, for example, the task of the air handling units is to ventilate and sometimes to cool, but not to heat the building; this is a task of the radiators.
- The smallest possible air handling unit is not always economically justified.

## Parameters for energy - and LCC<sub>E</sub>-calculation

The following factors are required in order to achieve high accuracy in our energy calculation:

- The heat transfer for each air heater, cooler, heat exchanger rests upon the condition of incoming air to each component. This implies that the condition of the air, (temperature, enthalpy, velocity, pressure) must be calculated for each point of the air handling unit.
- The cooling performance calculation for a cooling coil is complex, and in order for it to be correct the effect of condensing water droplets must be taken into consideration. The pressure drop across the water coil increases and the adiabatic cooling energy must be calculated.
- If a rotary heat exchanger is used for heat recovery, the leakage flow and balancing pressure must be included in the calculation. The extra pressure and the air flow affect the extract air fan.
- The pressure drop across the filters should be calculated as the mean value of the initial pressure drop and the final pressure drop.
- All electric energy consuming components should be included in the calculation, even pumps and other actuating motors that are part of the air handling unit.

## Temperature calculation

When calculating temperatures, the supply air and extract air temperatures for both summer and winter conditions should be specified. The temperatures are described as a linear change over a period of time in a duration chart. An extra increase in temperature arises across the fan and this increase should be calculated for each specific air handling unit. This influences both the heating loads and the cooling loads.

The set point for both temperature and moisture must be specified when calculating to obtain both correct temperature and correct humidity.

There are two different ways of calculating cooling performance:

1. Calculation to obtain the correct temperature.
2. Calculation to obtain both the correct temperature and the correct moisture content in the air.

An air handling function consisting of an air heater, a cooler and a reheater is needed when there is a need for accurate regulation of both temperature and relative humidity. This process is very energy demanding, therefore it is important that the calculation in such a case will be accurate.

The first chart shows how the temperature is cooled down to correct temperature. The second chart shows how the air is first cooled down to correct absolute moisture content and then is heated to correct temperature and correct relative humidity.

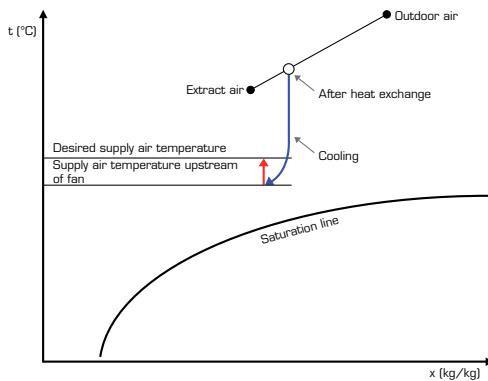

Calculation of the effect of cooling for obtaining correct temperature (Note! Mollier chart)

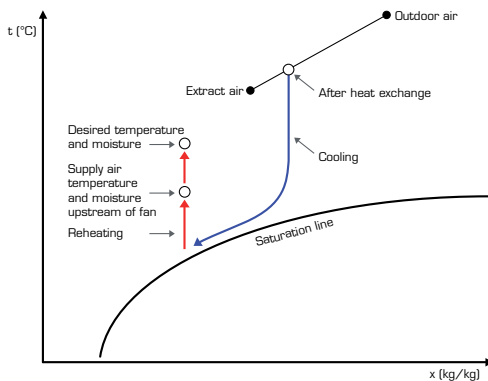

Calculation of the effect of cooling for obtaining correct temperature and correct humidity (Note! Mollier chart)

## Outdoor temperature compensation

In the majority of cases where there is an air cooler in an air handling unit, the supply air temperature varies during the year depending on the load. In order to, in these cases, be able to correctly calculate the energy load, it is a good idea if our calculation includes outdoor air temperature compensation.

With the outdoor air compensation function, the supply air temperature is calculated as a function of the outdoor temperature. The condition of the supply air is specified as actual temperature for various outdoor temperatures, between these points the temperature becomes linear over time.

The extract air temperature is specified as a summer temperature and a winter temperature and in between it is linear over time.

The illustrations below show how a chart may look, with compensation and without compensation respectively.

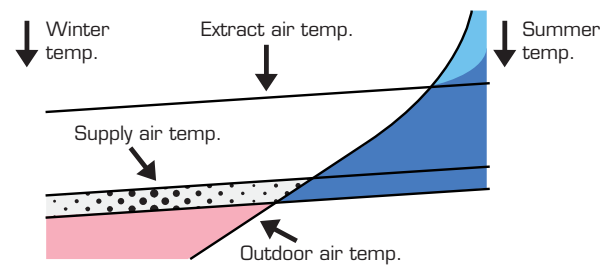

Chart without outdoor air temperature control

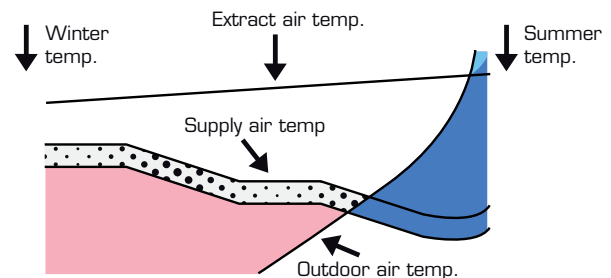

Chart with outdoor air temperature control

## Running times

The number of running hours has a substantial effect on energy consumption. For example, an air handling unit that operates all round the clock is in service approx. 8,760 hours per year; however in reality the operating hours of an air handling unit ventilating offices, for instance, will be 3,000 to 4,000 hours.

Therefore, it may be advisable to divide the operation of the unit into two modes: daytime and nighttime operation in our energy calculation. Each operating mode can have different flow and temperature settings.

The temperature is slightly cooler at night compared with during the day and this can be seen in the duration chart as a parallel displacement of the curve.

Daytime operation and night-time operation

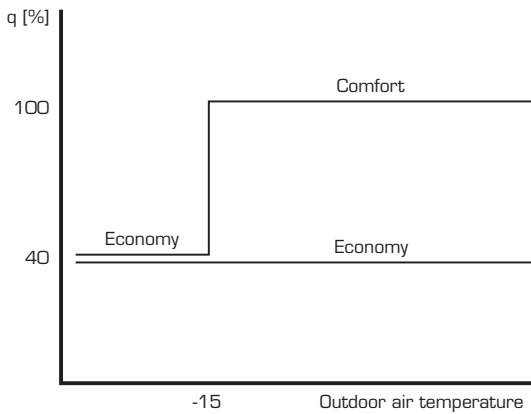

Duration chart, daytime and night-time operation

## VAV-system

The min. and max. air flow for each outdoor air temperature should be specified if we are calculating the energy consumption of an air handling unit that is pressure-regulated in step with a VAV system. The flow is assumed to be constant if the temperature is lower than the min. temperature set point, or higher than the max. temperature set point. The curve between the two temperatures is linear.

## Duration chart

A duration chart can be used for illustrating how much energy is consumed. See below!

The chart shows the supply air and the extract air temperatures for the specific air handling unit during the whole year. The chart shows the volume of energy recovered (pink area), excess heat (red area) and excess heat from the fan motor (dotted area) during the heating period. The chart shows the cooling energy recovered (light blue) and the amount of cooling energy required (blue area), and the excess heat from the fan motor (dotted area) during the cooling period. Reheating is also shown for cooling to both correct temperature and correct moisture content in the air. Only sensible heating and cooling energy are shown in the chart.

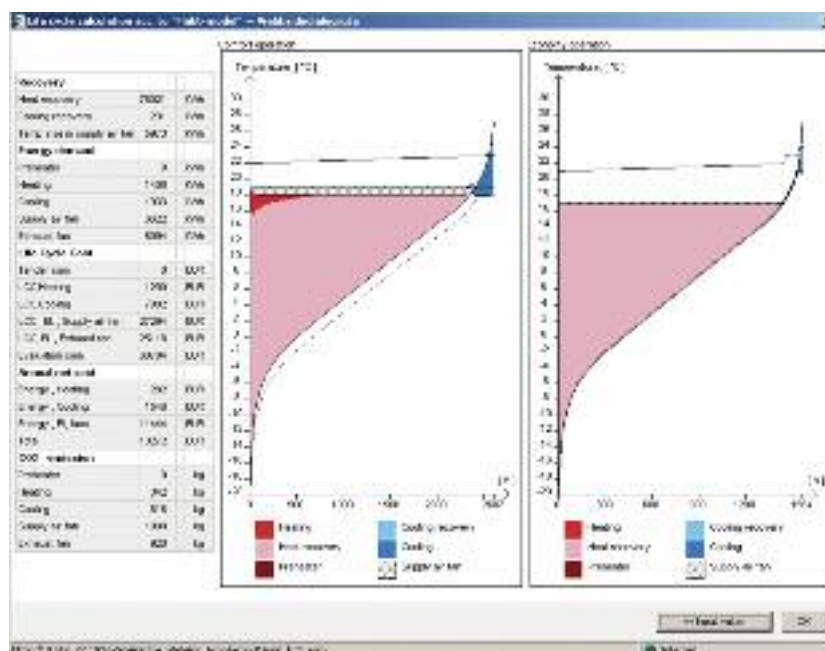

Duration chart, from Fläkt Woods product selection program, ACON



## Summary

The life cycle cost (LCC) is the sum of all costs related to a product during its useful life. Up to 90 % of the total life cycle cost for an air handling unit consists of energy costs. Energy efficient systems are therefore of crucial importance for the ventilation system's total economy. Therefore, it is important to calculate the life cycle energy cost,  $LCC_E$ , of the air handling unit. It is also possible to recalculate the amount of energy consumed to provide data on CO<sub>2</sub> emissions.

The following factors are required in order to achieve high accuracy in our energy calculation:

- The condition of the air, (temperature, enthalpy, velocity, pressure) must be calculated for each point in the air handling unit.
- The cooling performance calculation for a cooling coil is complex, and in order for it to be correct the effect of condensing water droplets must be taken into consideration.
- If a rotary heat exchanger is used for heat recovery, the leakage flow and balancing pressure must be included in the calculation.
- The pressure drop across the filters should be calculated as the mean value of the initial pressure drop and the final pressure drop.
- Your calculation should include all electric energy consuming components, even pumps and other actuating motors incorporated into the air handling unit.

- When calculating temperatures, the supply air and extract air temperatures for both summer and winter conditions should be specified.

There are two different ways of calculating cooling performance:

- Calculation to obtain the correct temperature.
- Calculation to obtain both the correct temperature and the correct moisture content in the air.

When the energy costs are to be calculated, it is extremely important to make use of the right necessary conditions to obtain results you can rely on.

The following points considerably influence the final results:

- The lowest investment cost/smallest air handling unit seldom is the same thing as lowest  $LCC_E$ .
- Economically optimized duct systems.
- Selection of correct fans.
- Optimized heat exchangers.
- Select heat exchangers that can also be optimized for recovering cooling energy.
- Ventilate the plant as needed.
- Use the air handling unit for its correct application.

# 9 Sound



### The chapter deals with the following

- General information about sound
- Sound pressure/Sound pressure level
- Root mean square value
- Sound power level
- Addition of sound levels
- Frequency
- Standard filter

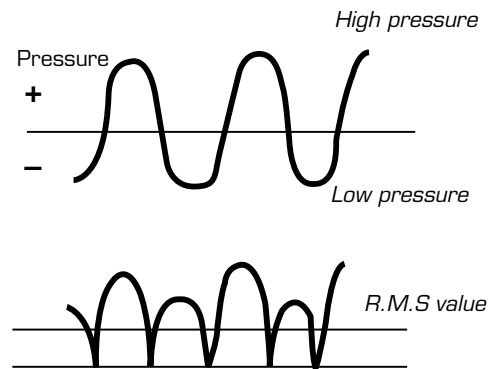

Sound pressure and the root mean square value (RMS)

A uniform and pleasant sound level along with temperature and air velocity is the most important demand made on a good indoor climate. Several of the comfort problems that can occur indoors can be solved by using an air conditioning plant that has been correctly sized. This presupposes that the building project has been carefully designed, including acoustic calculations as an important ingredient.

Besides fans and air handling unit, dampers and air devices are the biggest sound sources in an air treatment system. The sound of the fans can for example be spread to the rooms via the building structure or through the duct system itself, requiring sound attenuating measures. In the supply air systems as well as in extract air systems, sound absorbers must often be located near fans and dampers.

For an air diffuser, it is important that the need for sound reduction can only be met by changing the type, size of air diffuser, etc.

## Sound

Sound consists of pressure variations in the air (or other media) which causes the eardrum to vibrate. The root mean square value (RMS) of these pressure variations indicates the effective sound pressure  $p$  (Pa). The pressure  $p$  is compared with a reference value  $p_0 = 2 \times 10^{-5}$  Pa, which is regarded to be the lowest audible sound level; the threshold for audible sound.

### The sound pressure level is defined as

$$Lp = 20 \log \left( \frac{p}{p_0} \right) = 20 \log \left( \frac{p}{2 \cdot 10^{-5}} \right)$$

Where

$Lp$  = Sound pressure level, dB

$p$  = Sound pressure, Pa

$p_0$  = Reference value, Pa

In order to create pressure variations in the air we require an energy source. Sound pressure is then caused by one or several sound sources which generate sound power. Sound power is also compared with a reference level:  $W_0 = 10^{-12}$  (Watt)

### The sound power level is defined as

$$Lw = 10 \log \left( \frac{W}{W_0} \right) = 10 \log \left( \frac{W}{10^{-12}} \right)$$

Where

$Lw$  = Sound power level, dB

$W$  = Sound power, W

$W_0$  = Reference value, W

With sound power, we can describe the total sound energy that a machine emits regardless of surroundings. Sound pressure only describes the sound at one point. Sound will radiate from the casing of a machine when it vibrates.

The pressure waves are transmitted from the vibrating surface to the ear, precisely as rings on the water in a pond. When the waves propagate through the air, the friction effects gradually decrease them. The farther away we are from a sound source, the weaker it sounds.

The sound pressure level is dependent on the sound power level generated by the sound source, the characteristics of the surroundings e.g. absorption and the distance from the sound source. Because of this, acoustic data is specified in the product catalogue as Sound power, so that the resultant sound pressure level can be calculated.

**How to add sound levels:**

Since sound levels are logarithmic values, they cannot be added in a linear order. If we have two sound sources each at 50 dB, the sum will not become 100 dB. Sound levels must be added logarithmically.

$$Lp = 10 \log (10^{\frac{Lp1}{10}} + 10^{\frac{Lp2}{10}})$$

The sum of two sound sources each of 50 dB will then be  $10 \times \log (100\,000 + 100\,000) = 53$  dB.

This means that when two sound sources of the same strength are added together the total sound level becomes 3 dB higher.

The increase becomes smaller than 3 dB when two different levels are added together. The increase is insignificant when the difference between the levels is more than approx. 12 dB. With a difference of 2 dB, the increase will be approx. 2 dB and for a difference of 6 dB, the increase will be 1 dB. The following chart can be used for adding sound levels:

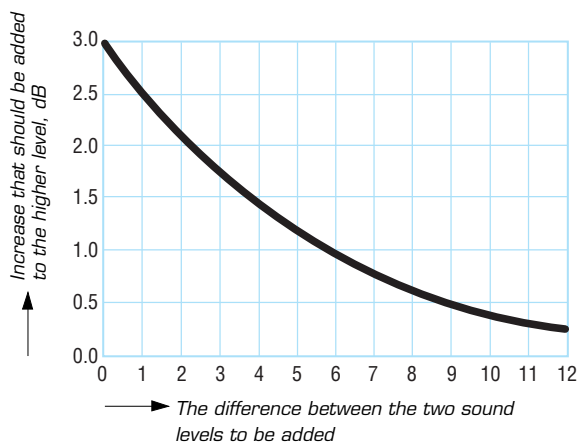
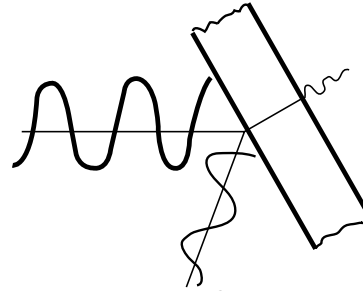

Chart for the logarithmic addition of the difference between the two sound levels to be added

Three things happen when sound waves meet another surface: some of the energy from the wave is absorbed

by the material, some passes through to the other side and the rest is reflected by the surface. See the figure below.



Sound waves that meet a surface

The difference between the incident sound power level and transmitted sound power level is called sound absorption. Sound absorption is linearly subtracted from the sound level.

**Frequency**

The number of waves hitting your eardrum per second is called frequency,  $f$  (Hz) and the distance between "crests" of waves is called wave length,  $\lambda$  (m).

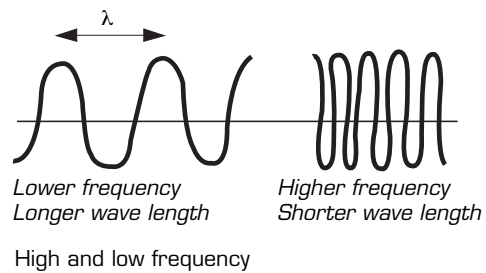

The speed,  $c$ , at which sound propagates, depends on the medium through which it propagates. The speed of sound through air is about 340 m/s, and the relation between wave length ( $\lambda$ ) and frequency ( $f$ ) is given expressed as:

$$c = f \lambda$$

Where  
 $c$  = The speed m/s  
 $f$  = Frequency, Hz  
 $\lambda$  = Wave length, m

A musical instrument can produce several clean tones which are sound producing on a frequency. Machines ordinarily generate sound on a wide spectrum of frequencies, sometimes with crests on certain frequencies.

For humans, audible sound is between 20 and 20 000 Hz. On frequencies between 100 and 5000 Hz are the ones that we can hear the best. For practical reasons sound data is presented in catalogues as a total value for each of the eight octave bands:

Band							
1	2	3	4	5	6	7	8
Centre frequency, Hz							
63	125	250	500	1000	2000	4000	8000
Frequency range, Hz							
44– 88	88– 177	177– 354	354– 707	707– 1410	1410– 2830	2830– 5660	5660– 11300

## Standard filter

We would often like to compare sound levels by using one single number. This can be done by logarithmically adding the sound levels in each frequency band to give one single number. This method is often used to present the sound level in fan charts. However, the human ear cannot hear the equally well on all frequencies. We can hear the higher frequencies much better than the lower ones. A few standard filters have been invented, for example dB(A), in order to indicate sound pressure level and at the same time take into consideration how our ears work.

The A-filter simulates the ear well up to about 55 dB, but is usually used for other purposes, (fans often generate sound in the 80 to 100 dB range). dB(A) filter values are added from the sound pressure level in each band. The total dB(A)-value is obtained by logarithmically adding the resultant A-weighted sound levels.

At low levels, in a residential building, for instance, the A-weighting describes how sensitive our ear is to sound level at various frequency bands. The chart shows the A-weighting in the various octave bands.

Band							
1	2	3	4	5	6	7	8
Centre frequency, Hz							
63	125	250	500	1000	2000	4000	8000
dB(A) filter							
-26	-16	-9	-3	0	1	1	-1

At high levels, in a noisy workplace, for instance, A-weighting shows our sensitivity to hearing damage when sound levels are high. The authorities in many countries have stipulated maximum permissible noise levels in the workplace.

## What generates sound in an air handling unit?

The main components in an air handling unit that generate sound are of course the fans. Like other machines, fans produce a wide band of sounds, the level of which is dependant on the air flow velocity and the pressure developed by the fan. The sound generated by a fan is ordinarily a function of the air flow velocity and the pressure generated, but there are other factors which influence both the level and characteristics of the actual sound being generated. Our data from the catalogue is based on measured data obtained by tests carried out in our fan test chamber. Sound data is presented in the fan charts in the catalogue in form of Total Sound power level; Lwt. Other components in the air handling system usually attenuate sound, but can also give rise to natural sound. It is important to insulate the ducts properly, since the sound inside ducts can pass through the duct wall to the air handling unit plant room.

The sound pressure level in the air handling unit plant room depends on its form, size and on how much sound absorbing material there is in the room. Other machines in the room will of course also affect the total sound level.



## The relation between sound power and sound pressure

Sound pressure can be estimated from the sound power level by the following conditions.

Sound pressure level in a duct:

$$Lp = Lw - 10 \log A$$

Where

$Lp$  = Sound pressure level, dB

$Lw$  = The sound power level, dB

$A$  = The cross section area of the duct, m<sup>2</sup>

If the duct is smaller than 1 m in circumference the value of the sound pressure level will be higher than the sound power level. For ducts larger than 1 m the opposite is true.

## Outdoors

Sound radiates in three dimensions from a sound source. If there are no walls or ceilings to reflect the sound, then we can regard its propagation as being hemispherical.

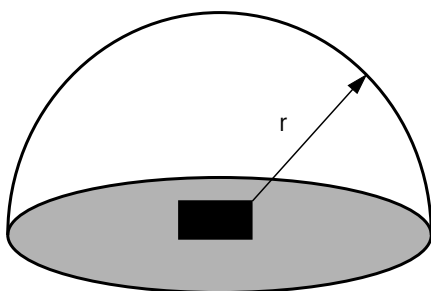

The radius  $r$  from the sound source

The sound pressure level by the radius  $r$  from the sound source is expressed as:

$$Lp = Lw - 10 \log 2\pi r^2$$

Where

$Lp$  = Sound pressure level, dB

$Lw$  = The sound power level, dB

$r$  = The radius, m

In practice outdoor sound levels are influenced by surrounding buildings and wind conditions.

## Indoors

The sound indoors is radiated depending on where the source is placed in comparison to walls, floors and ceilings. Energy is also absorbed by the surfaces inside the room. Soft surfaces tend to absorb more energy than hard surfaces. The capacity of a surface to absorb energy is specified as the sound absorption coefficient  $\alpha$ .

$\alpha$  is a value which ranges between 0 and 1 and which normally is frequency dependant. To describe the sound absorption in a room, the surface areas are multiplied by different materials in the room with their correlation number and then they are summed up.

$$A = A_1 \cdot \alpha_1 + A_2 \cdot \alpha_2 + A_3 \cdot \alpha_3 + \dots + A_n \cdot \alpha_n$$

Where

$A$  = Equivalent sound absorption area, m<sup>2</sup>

$A1-n$  = Area for the individual surfaces in the room

$\alpha$  = Sound absorption coefficient

The plant room is normally rather "hard" with regard to sound. Walls, floors and ceilings are normally not covered with any soft materials. The ducts should however be insulated and this can provide some absorption in the room.

Another definition of room absorption is given by the reverberation of the room. The reverberation period is the time it takes for the sound level in the room to drop by 60 dB when a sound source is suddenly switched off.

$$T = 0.16 \cdot \frac{V}{A}$$

Where

$T$  = Reverberation period, s

$V$  = The room volume, m<sup>3</sup>

$A$  = Equivalent sound absorption area, m<sup>2</sup>

The formula is applicable to rooms with low absorption ( $\alpha$  below 0.2) which is normal in practice.

Plant rooms should normally have a very low  $\alpha$  value and 0.05 to 0.1 is typical. This means that the sound pressure level in air handling unit plant room will be more or less the same as the sum of the sound power levels for various machines inside the room.

## Sound level in occupied spaces

The air handling unit supplies air to all sorts of rooms, from large industrial machine halls to bedrooms in hotels. Some rooms are very hard while others are soft. There are charts which give average sound absorption figures for various types of rooms.

Note that the sound can pass to the room not only by passing through the duct, but also through walls, floors and ceilings as well as through the air. All sound paths must be taken into consideration when calculating the overall sound pressure level.

## How to select a quiet air handling unit:

There are several factors that affect the sound levels emitted from an air handling unit.

### Some points to ponder:

1. Select air handling unit with low air velocity.
2. Select a large fan for low sound level.
3. Use higher density insulation on the casing.

Do not exaggerate!

Remember that sound can pass into the duct from the air handling unit plant room and destroy performance. Duct bends and other duct components can also generate sound, so in certain cases it might be better to install the final sound absorber closer to the room.

Also remember that even sound absorbers generate sound and there is a lowest level we can attenuate to, by using conventional silencers.

## Summary



A uniform and pleasant sound level along with temperature and air velocity is the most important demand made on a good indoor climate. Sound consists of pressure variations in the air (or other media) which causes the eardrum to vibrate. The root mean square value (RMS) of these pressure variations indicates the effective sound pressure  $p$  (Pa).

The effective sound pressure together with a reference pressure value, the lowest possible audible sound level, is used in order to calculate the sound pressure level.

Sound pressure level describes the sound at only one point. In order to describe the total sound energy emitting from a machine, we use the concept: sound power.

Sound levels are logarithmic values and must therefore be logarithmically added

The number of waves hitting the eardrum per second is called frequency,  $f$  (Hz) and the distance between the wave "crests" is called wave length,  $\lambda$  (m).

The speed,  $c$ , with which sound propagates, is contingent on the medium through which it propagates.

The speed can be calculated from wave length ( $\lambda$ ) and frequency ( $f$ ).

Often we would like to compare sound levels by using one single number. This can be done by logarithmically adding the sound levels in each frequency band in order to give one single number. A few standard filters have been invented, for example dB(A), in order to indicate sound pressure level and at the same time take into consideration how our ears work.

Sound radiates in three dimensions from a sound source. If there are no walls or ceilings to reflect the sound, then we can regard its propagation as being hemispherical. Sound radiates in the same manner indoors, but some of its energy is absorbed, by the surfaces in the room.

Soft surfaces tend to absorb more energy than hard surfaces. The capacity of a surface to absorb energy is specified as the sound absorption coefficient,  $\alpha$ .

There are a number of factors which affect the sound levels emitted from an air handling unit.

### Some points to consider:

1. Select air handling unit with low air velocity.
2. Select a large fan for low sound level.
3. Use thicker insulation on the casing.

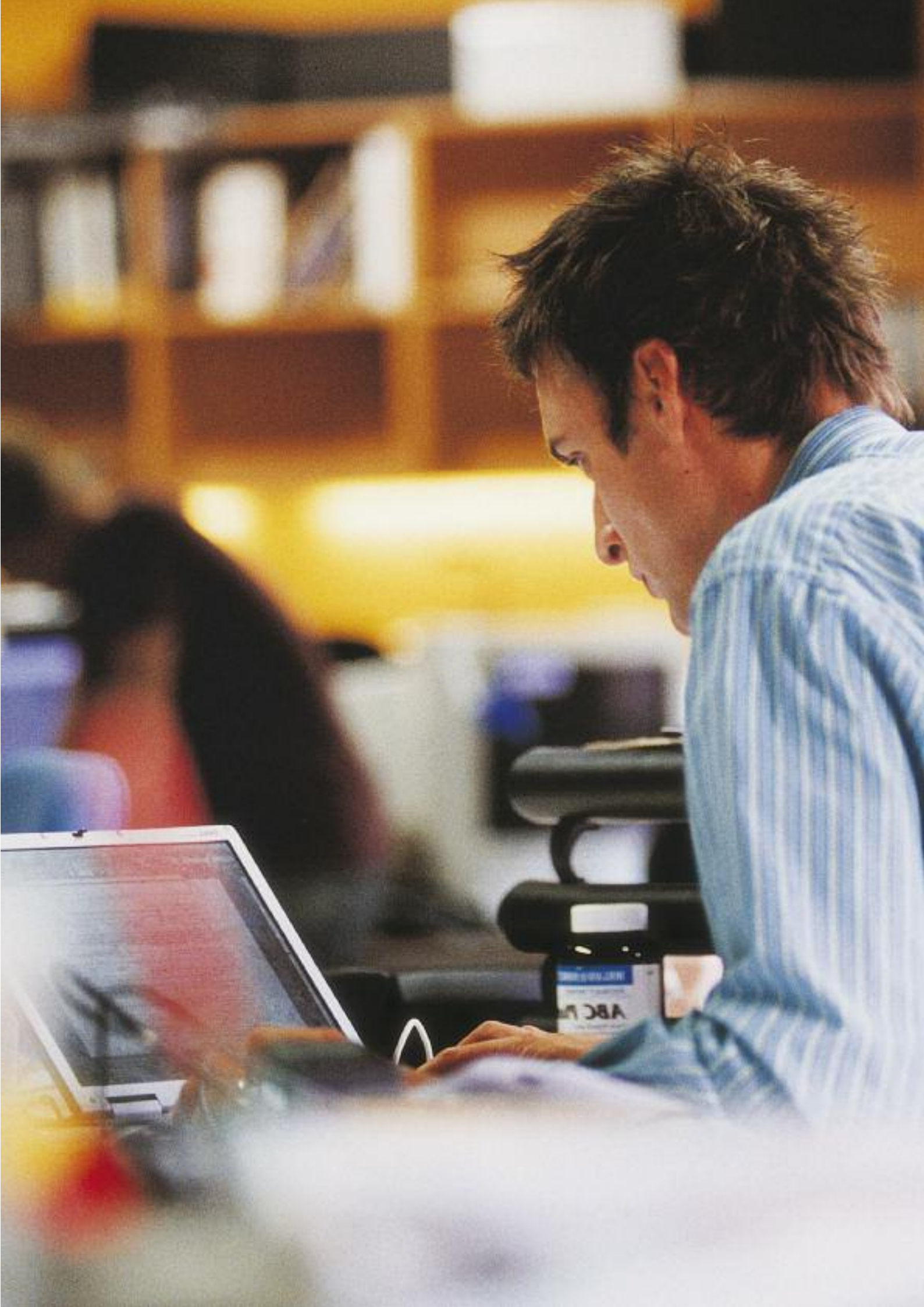

# 10

## Dampers

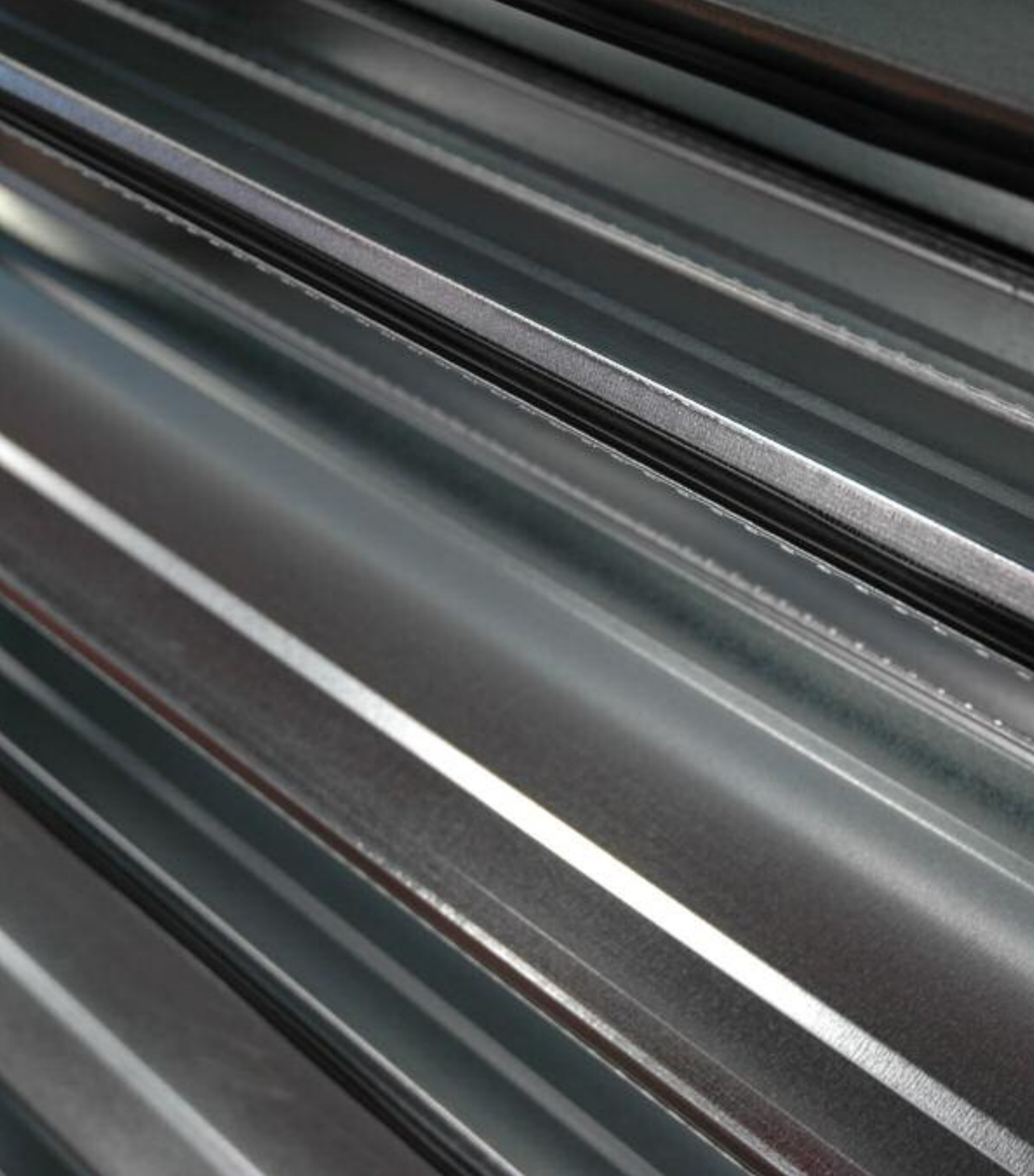

### The chapter deals with the following



- What the damper is designed to be used for in an air handling unit.
  - Regulation of the airflow
  - Mixing of airflows
  - Regulation of by-pass airflow
  - Shut off
- The damper performance
- Mixing properties
- Air leakage

An damper is a type of valve which is used for regulating the flow in a duct or in an air handling unit.

In air handling units, the dampers are intended for:

- Regulation of the airflow
- Mixture of airflows
- Regulation of by-pass airflow
- Shut off



Damper operation

## Regulation of airflows

When the blades of the damper rotate from the horizontal position to the vertical position, the pressure drop gradually increases across the damper. This increase in pressure drop will cause the flow to decrease.

## Mixing of airflows

In applications where the intermixture of return air is permissible, three dampers are used for regulating the return airflow, the fresh airflow and the exhaust airflow.

The mixture is regulated so that the minimum requirement for fresh air is achieved, while the requirement for more heating or cooling is minimized.



Mixing

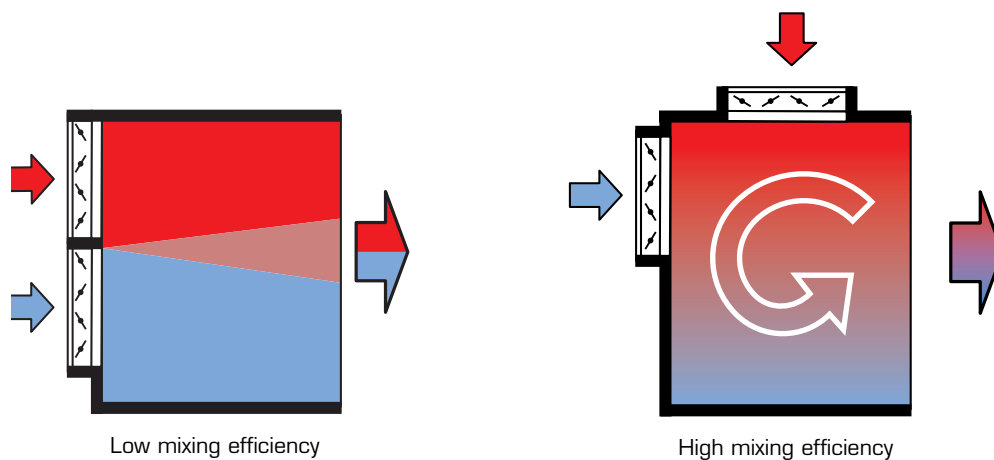

## Mixture properties

When we are considering the mixture properties, we only need to consider the case with two dampers in the supply air section of the air handling unit. The two dampers are installed in a mixing box so that the one damper is used to regulate the outside air flow, while the other damper regulates the return air flow.

The two air flows meet one another inside the mixing box. We would preferably like the two airflows to totally mix with one another, so that the air that leaves the mixing box would have a uniform temperature across the entire cross section of the air handling unit.

The ability of the mixing section to blend warm and cold air is expressed as mixing efficiency and has been defined in the form of a CEN Standard.

Researchers have found that the mixing efficiency is high in mixing sections that have dampers arranged at straight angles to one another, while mixing sections that have the dampers arranged on same wall next to one another tend to have lower mixing efficiency.

Where the mixing efficiency is low, we see that the air flow behind the mixing box is stratified, so that the air is colder at the bottom of the functional section. This may give rise to problems with components which are placed downstream, such as coils and filters.

In extreme cases the cold air may cause a coil to freeze and burst. A temperature sensor which is located behind mixing section, intended to regulate, may transmit a faulty temperature signal.

## Regulation of by-pass airflow

Dampers can also be used for regulating the by-pass flow in certain functions in the air handling unit, such as the plate heat exchanger.

In this case, a portion of the air is permitted to pass by the plate heat exchanger in order to regulate the volume of heat recovered and so the supply air temperature. The by-pass function is also used for defrosting. In air handling units with rotary heat exchanger, a damper can be used to lower the pressure on the extract air side in order to prevent leakage to the supply side.

By-pass is sometimes used as a means for regulating the flow through heating and cooling coils. The air handling unit functional section is divided into two sections; the one consists of the coil and the other consists of the air damper. The coil can also be equipped with a front damper, for permitting full regulation of the airflows. When it comes to heating coils, this method allows the supply air temperature to be regulated, without any need to reduce the velocity of the water flow. This is a way to avoid frost from forming in the coil in cold climates. When it comes to cooling coils, the by-pass damper can be used, to a certain degree, for regulating the condition of the supply air by mix-

ing temperature and humidity. However, there is risk of condensate forming on the surfaces inside the air handling unit downstream of the cooling coil.

## Shut off

There are a number of different kinds of shut-off dampers. Each one of them is designed for a special task. Simple regulation dampers such as dampers with counter-rotating damper blades are used for closing off the duct system when the fan is not running. More complex dampers are available on the market for fire and smoke control. These dampers are normally kept fully open, in the event that smoke or high temperatures are detected, they are quickly shut in order to prevent the spread of fire and smoke.

Another type of shut-off damper is the airstream-operated damper. This type of damper is often used on the outlet side of the extract air fan, in order to prevent wind from blowing in air in the wrong direction through the duct and the fan, when the fan is not running.



Open damper. The filter is visible behind the damper.



Closed damper.



## Damper blades

Dampers may be manufactured with either counter-rotating or parallel-rotating blades. The two different designs have different regulating properties. The regulating characteristic of the air damper is also a function of the pressure drop in the entire system. If the pressure drop in the system is high, a high pressure drop across the damper is needed, if adjustment of the damper position is to be used for influencing the airflow. Normally the pressure drop in the system will be considerably higher than the pressure drop of the damper in the open position.

The charts show examples of how the airflow varies with the blade position of the air damper for different values of  $\alpha$  where  $\alpha$  is the condition between the pressure drop across the entire system, and the pressure drop across the air damper in the fully open position.

The ideal characteristic is the one which provides a linear relation between the position of the air damper and the airflow. The charts show that the air damper with counter-rotating damper blades gives rise to a more linear characteristic for higher values of  $\alpha$  which is desirable in an air handling system.

For that reason dampers with counter-rotating damper blades are commonly used in air handling units.

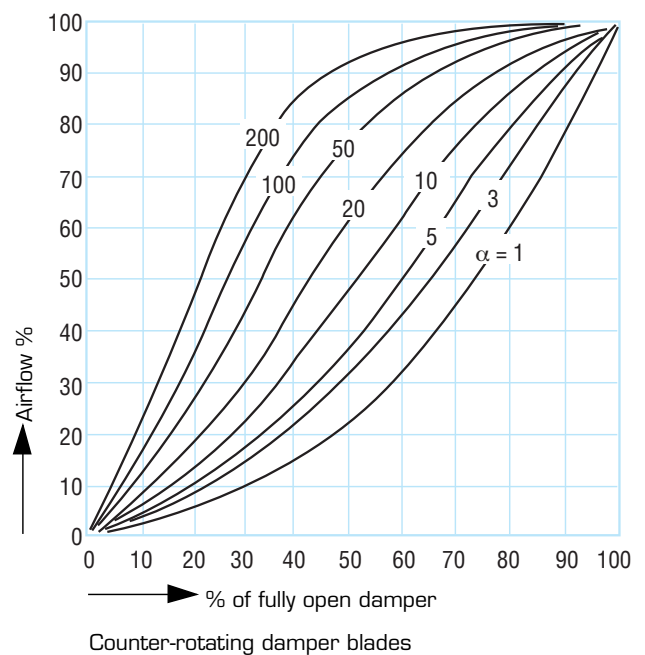
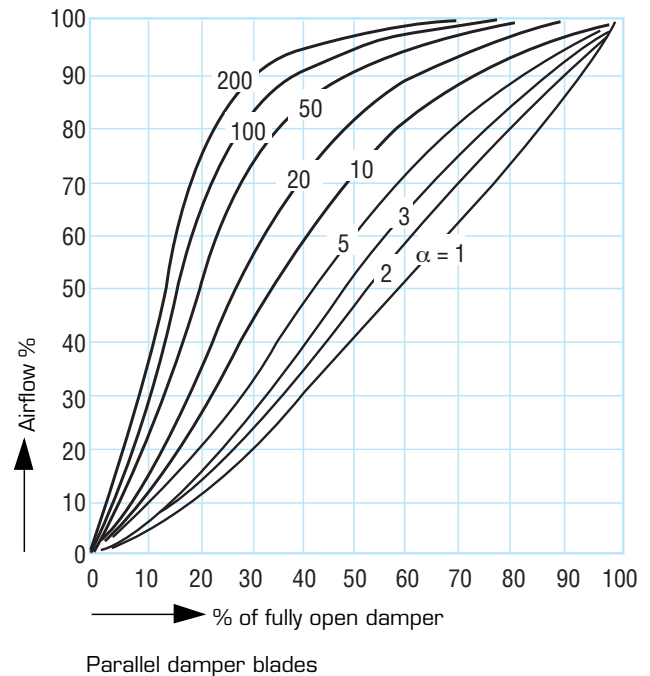

## Air leakage from closed air damper

The air leakage across an air damper in the closed position is an important characteristic and is defined by a CEN-standard.

The tightness of dampers in the closed position depends on the stiffness of the damper blades, the quality of gaskets fixed to the edges of the damper blades and the gaskets between the ends of the blades and the air damper frame.

### Tightness classes for dampers mounted in air handling units

CEN Classes	4	3	2	1
-------------	---	---	---	---

## Air leakage in the air damper casing

Air leakage through the air damper casing is also defined by a CEN Standard.

## Required torque

In order to select suitable damper actuator you must know torque required for turning the damper blades.

## Pressure

A damper is designed for a certain pressure difference which must not be exceeded. It is therefore important to check the technical data furnished by the damper supplier.

The range of leakage performance has been divided into classes 0, 1, 2, 3 and 4:

Classes 1, 2, 3, 4

See figure for permitted maximum leakage  $q_{VLBA}$  in  $1 \cdot s^{-1} \cdot m^2$  across closed blades as a function of duct static pressure  $p_s$  in Pa.

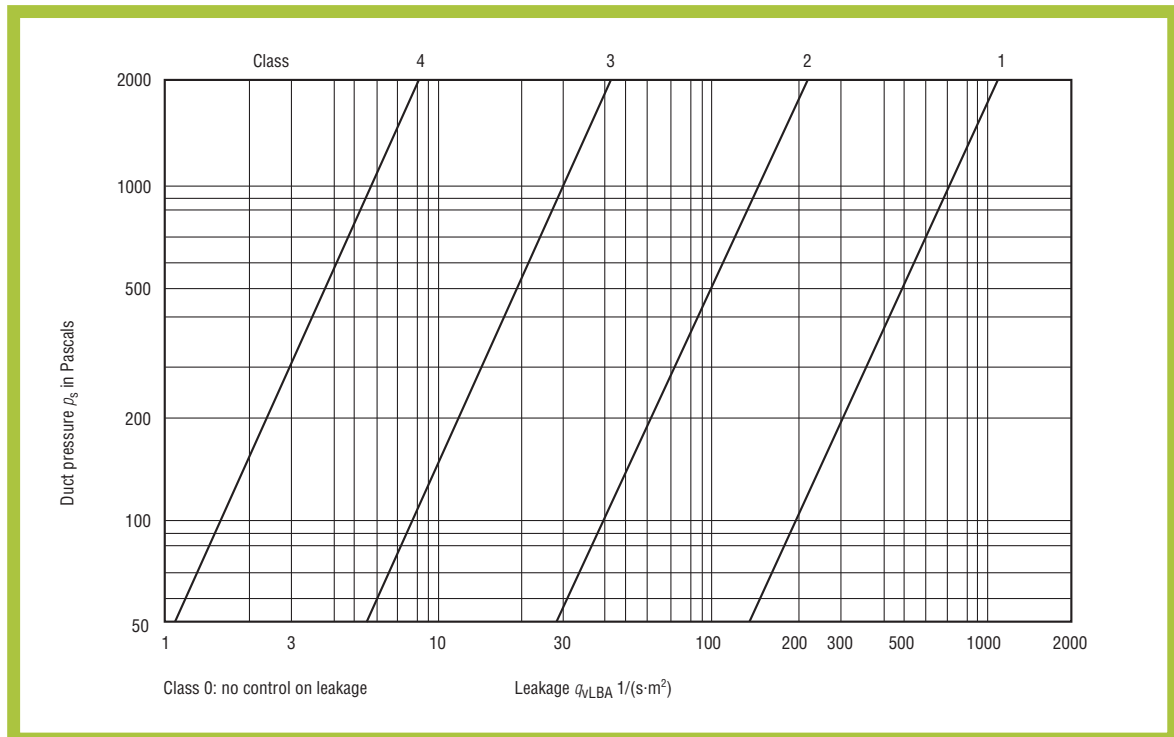

Classification of closed blade leakage

## Summary



An air damper is a type of valve used for regulating, mixing and shutting off the airflow.

### **In air handling units dampers are designed for:**

- Regulation of the airflow
- Mixing airflows
- Regulation of a by-pass flow
- Shut off

### **Damper blades**

Dampers can be manufactured with either counter-rotating or parallel-rotating blades. The two different designs have different regulating properties. The regulating characteristic of the air damper is a function of the pressure drop in the entire system. Dampers with counter-rotating damper blades are commonly used in air handling units because these dampers have a characteristic which is well-adapted to air handling systems.

### **Mixing properties**

Where mixing sections have dampers arranged at straight angles to one another, the mixing efficiency is usually high, whereas those that have dampers placed on the same wall next to one another tend to have lower efficiencies. Where the mixing efficiency is low, we see that the airflow downstream of the mixing box is stratified, so that the air is colder at the bottom of the functional section.

### **Tightness and leakage**

The tightness of an air damper in the closed position depends on the stiffness of the damper blades, the quality of gaskets fixed to the edges of the damper blades and the gaskets between the ends of the blades and the air damper frame. Air leakage is defined in a CEN Standard. In order to be able to select suitable damper actuator you must know the torque required for turning the blades.



# Filters



### The chapter deals with the following



- The function of the filter
- Impurities in the air around us
- How a particle filter works
- How particle filters are tested and classified
- Pressure drop across particle filters
- Carbon filters
- Filters in air handling units
- Installation

The air-borne pollutants generated by humans, materials and processes in a building must be removed by means of ventilation. It is then important that the outdoor air supplied is as clean as possible.

Filters are used for cleaning air. In most ventilation systems, a filter is located immediately downstream of air handling unit inlet where it cleans the incoming outdoor air. The extract air, i.e. the air that comes from the rooms, is often cleaned in a similar way. The filter protects the air handling unit and the supply air ducts from impurities, reduces the need for cleaning and improves the air quality in the rooms at a given rate of air change.

When it comes to the ventilation of operating theatres and sensitive manufacturing processes, the air filtration function will have to be especially efficient. This calls for the use of highly efficient HEPA filters (high efficiency particulate filters).

Carbon filters are used at airports, in museums and for the extract air from kitchens, for instance, for cleaning air to remove gases.

The function of the air handling system is to create good air quality in the premises. Every day we breathe 20 – 30 m<sup>3</sup> of air, and we do most of this (ca 80 %) indoors. Surveys have shown that the air indoors is of such poor quality that many people become sick. What requirement level we have depends on how we use the room. While office rooms demand a specific level and accordingly a certain filter solution, operation theatres and clean rooms require completely different filter solutions.

## Impurities in the air around us

The air around us contains a great many impurities. Many have a natural origin such as viruses, pollen, spores from plants, etc. Others come from human activities e.g. combustion, traffic and industry. The latter are generally the most harmful ones, because they contain greater amounts of toxins and that they are more respirable. Pollutants consisting of particles, or those that are bound in particles, are arrested in particle filters whereas the pollutants that are in gas form are separated by means of carbon filters.

Air pollutants come in a variety of sizes, see the figure on the next page. They exist as molecules, viruses which are smaller than 0.01 µm, and pollen and dust which can be up to 100 µm for example.

Particles larger than 10 µm fall relatively quickly toward the ground. The concentration of these is therefore largest close to the ground. Roughly only 0.1 % of the particles in the atmosphere close to the ground are larger than 1 µm, but that part contains about 70 % of the total mass of the dust.

The variation in the size of impurities make different demands on the filter. In order to dispose of the larger pollutants it is enough to use a simpler filter with relatively coarse fibres, so called wide-meshed filters. In order to separate smaller particles fine filters or high effective HEPA-filters with fine-meshed netting of fine fibres are required.

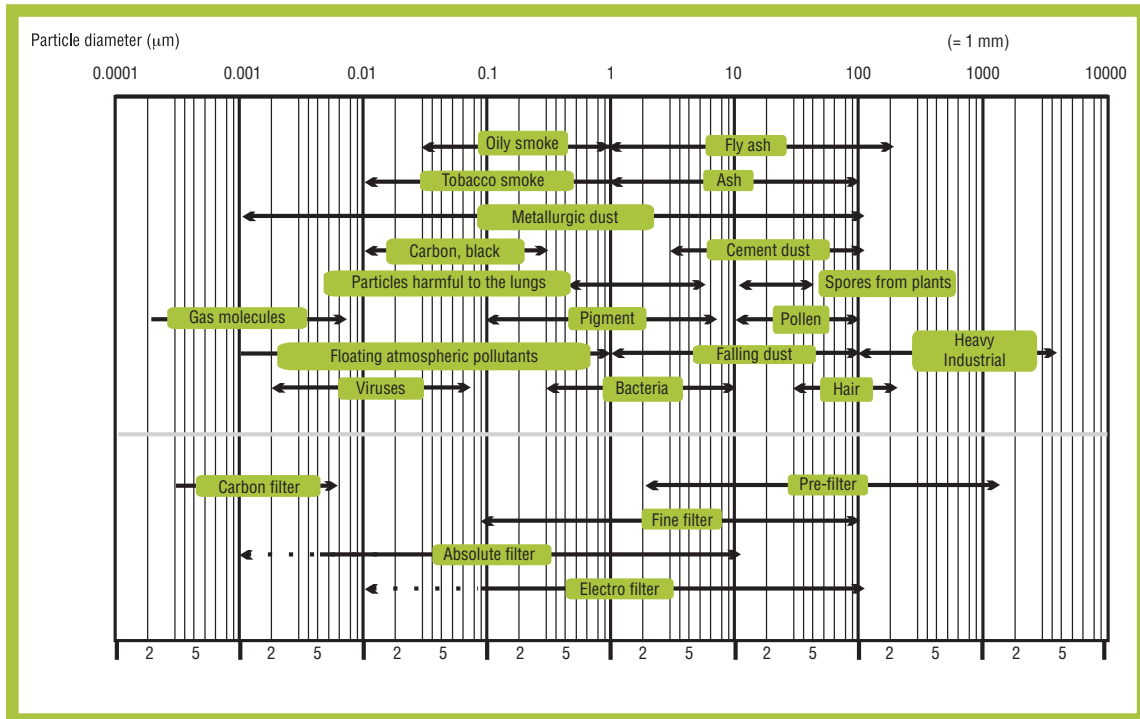

Particle sizes

## How does a particle filter work?

A particle filter consists mainly of one or several layers with thin fibres of micro glass or synthetic material (plastic), pleated or sewn to bags and held together by a frame of steel, plastic or wood.

The diameter of the filters is on the order of 1 – 10 μm. Micro glass filters have thinner fibres than the synthetic filters.

There are also simple filters composed of aluminium fabric. These filters are washable.

As air passes through the filter, a certain portion of the air particles in the air will be arrested on or between the filter fibres. The more fibres the filter has and the thinner they are; the more particles will be separated from the air.

The pressure drop across the filter increases as dust is collected. The separation capacity also increases. The increase in pressure drop reduces the air flow in the ventilation system, or causes the fans to consume more electric power if the air handling unit includes provision for compensating air flow. In order to reduce the pressure drop across the filter and increase its useful product life, the filter is composed of a number of bags. The ability of a particle filter to collect particles depends mainly on four different mechanical effects and one electrostatic effect. The mechanical effects are: the Straining effect, Interception effect, Inertia effect and Diffusion effect. The electrostatic effect occurs in connection with certain synthetic filters. This effect occurs at the same time as the mechanical ones, but decreases relatively

quickly. Then only the mechanical effects are left. The total collecting efficiency is the combined effect of the different ways of collecting impurities. The chart below shows how the four mechanical effects cooperate to give a total collecting efficiency for a micro glass filter of class F7. We can see that the collecting efficiency varies with particle size and has a minimum for particles with the diameter of ca 0.25  $\mu\text{m}$ . Such a minimum is typical for all particle filters and the particle size there is named MPPS (most penetrating particle size). The penetration in a filter is the same as with 1 percentage collecting efficiency. Diffusion is the completely dominating effect for small particles. In order for the filter to have a high collecting efficiency for small particles, the filter must have many thin fibres.

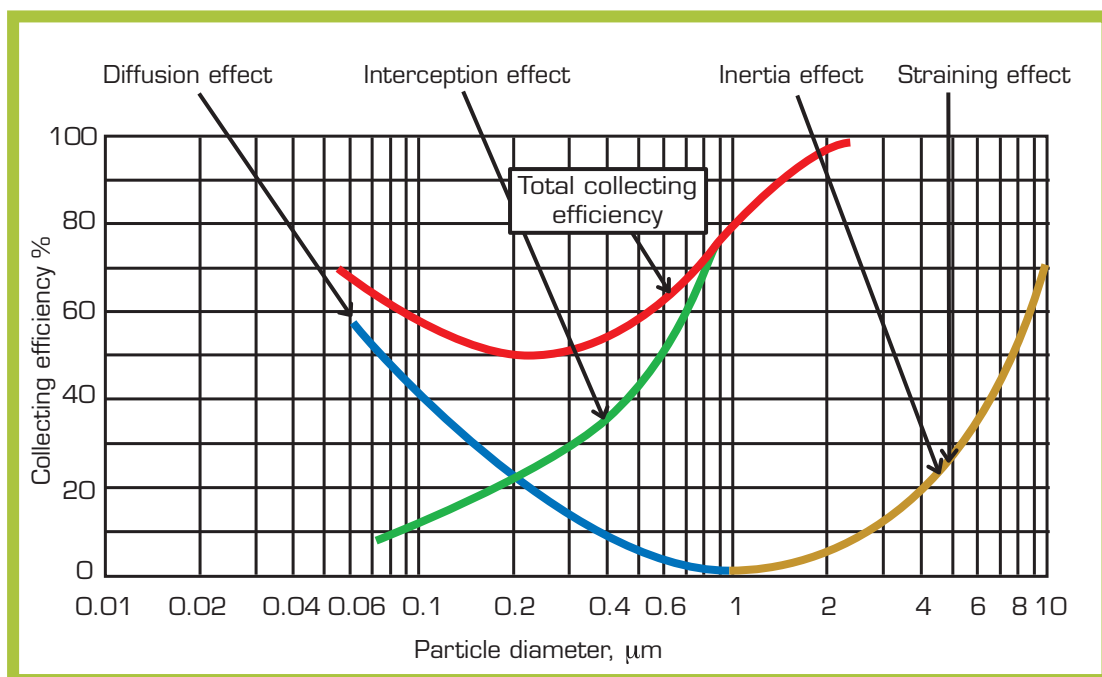
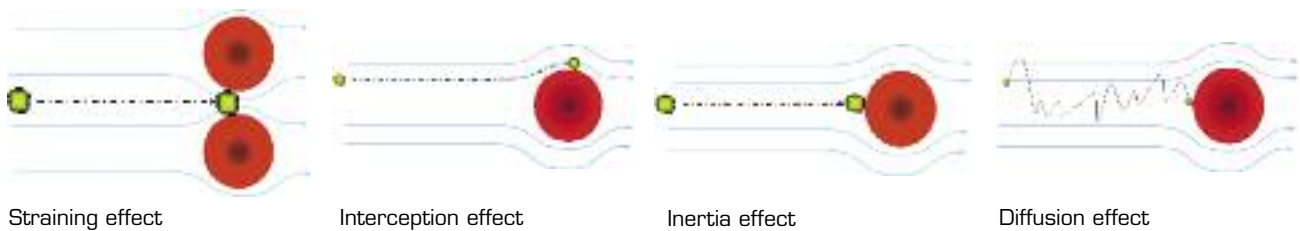

Collecting efficiency of a class F7 filter



## Testing and classification of particle filters

A particle filter intended for a ventilation plant is tested and classified in accordance with CEN standard EN 779: 2002.

The collecting efficiency, specified as a percentage, is tested for aerosols in the size of  $0.4 \mu\text{m}$ . The tests are carried out in a number of steps adding synthetic dust to the air up to the final pressure drop and the mean value of the collecting efficiency,  $E_m$  is calculated. If the  $E_m$  is less than 40 %, the filter is a wide-meshed filter (G) and it is then classified according to its ability to collect the synthetic dust  $A_m$ . If the  $E_m$  is the same as or more than 40 %, the filter is a fine filter (F) and is classified according to a mean value of its ability

to collect size  $0.4 \mu\text{m}$  particles, when synthetic dust is supplied to the filter in steps up to the final pressure drop of 450 Pa.

To make clear how much of the filter's collecting ability is conditional on its possible electrostatic charge, EN 779 indicates in an appendix how the filter's charge should be eliminated. After it has been neutralised, the filter should be tested and the result should be entered in the test report.

A filter for very high collecting efficiency for example a HEPA- or ULPA-filter is classified to EN 1822.

The classification is based on the collecting efficiency for the particle size that gives the smallest collecting efficiency, i.e. at MPPS. Each filter of HEPA – class H 13 and H 14 is tested individually in conjunction with the manufacture.

Classification of filter in accordance with EN779				Filters can also be classified as follows	
Class	Final pressure drop Pa	Ability to separate synthetic dust, $A_m$	Mean value of the collecting efficiency, $E_m$	EUROVENT 4/5	ASHRAE
G 1	250	$50 \leq A_m < 65$	-		
G 2	250	$65 \leq A_m < 80$	-		
G 3	250	$80 \leq A_m < 90$	-	EU3	G85
G 4	250	$90 \leq A_m$	-	EU3	G90
F 5	450	-	$40 \leq E_m < 60$	EU5	F45
F 6	450	-	$60 \leq E_m < 80$	EU6	F65
F 7	450	-	$80 \leq E_m < 90$	EU7	F85
F 8	450	-	$90 \leq E_m < 95$	EU8	F95
F 9	450	-	$95 \leq E_m$		

## Pressure drop across particle filters

A particle filter in operation collects dust and continuously builds up an even larger pressure drop. If the filter surface is large, the build-up is slower than if the filter has a small surface. The supplier of the ventilation equipment specifies an appropriate final pressure drop for the filter as well as a design pressure drop. The latter is normally between the initial pressure drop (clean filter) and the final pressure drop and is the pressure drop used for sizing the fan.

In a ventilation system where the fan runs at a constant speed, the flow will be somewhat higher when

the filter is clean than when it has reached its final pressure drop. The difference depends on the characteristic of the fan and on how large the pressure drop is across the filter seen in relation to the total pressure drop.

If the fan is controlled towards a constant air flow, the fan will have to work harder when the filter becomes fouled.

The chart below shows typical pressure drops across clean filters, as a function of the air flow through a size 600x 600 mm filter cassette.

The chart gives recommended pressure increases for different filter classes for determining design and final pressure drops.

### Recommended pressure rise for clean filter, Pa

	G 2	G 3 - G 4	F 5	F 6 - F 9
To dim. pressure drop	35	35	50	50
To final pressure drop	70	70	100	100

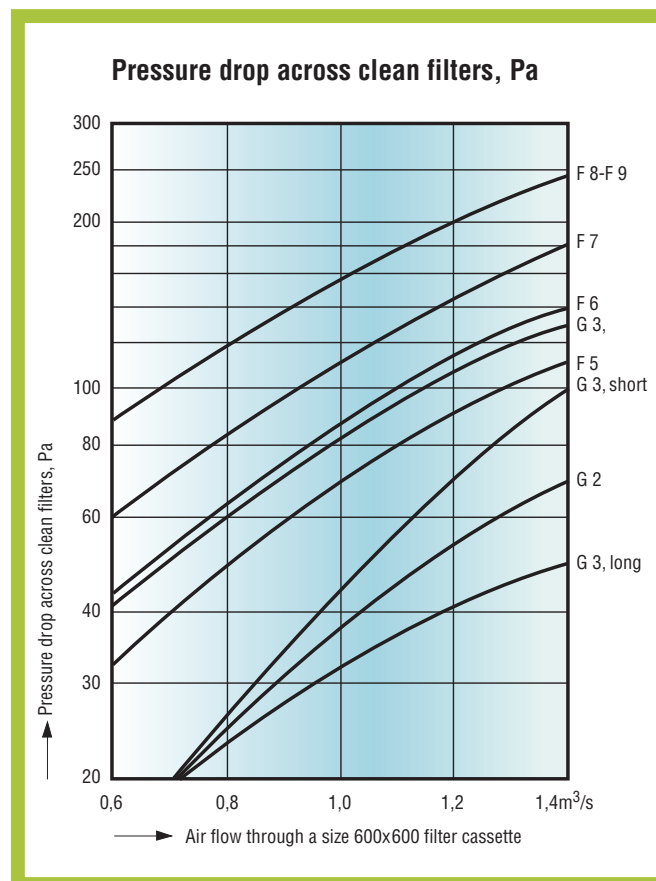

## Carbon filters (Sorption filters)

Gas filters are required for removing odours and other unwanted compounds in gas form. They are usually based on carbon. The air passes through a bed of activated carbon. It is a micro porous material with an active area up to 1500 m<sup>2</sup> per gram. The activated carbon has a tight network of pores and cracks where above all large molecules such as odours bind through adsorption.

Through impregnation with a chemical substance, a carbon filter can be adapted for collecting one or several specific gases as e.g. hydrogen sulphide, sulphur oxide and ammoniac. Carbon filters have nearly 100 % collecting efficiency up to the point when the carbon is almost saturated. After that, the collecting efficiency decreases very quickly. Carbon filters which have become saturated by adsorption can be reactivated by heating them. The period of time that the air is in contact with the carbon is an important parameter for obtaining good collection. The lower the concentration we want to remove, the longer the contact time required.

Today there is no European standard for the testing and classification of carbon filters. There is a Nordtest standard.

## Pre-filters

---

Pre-filters are used in air handling units in order to increase the useful product life of the most expensive fine filters.

Class G3 – G4, wide-meshed filters are often used as pre-filters. Despite the fact that they are simple filters and only take the larger pollutants, the major part of the dust volume is collected in the pre-filters.

## Filters in air handling units

Filter cassettes come in a number of sizes. The most common are the so-called whole and half cassettes, 600x600 and 600x300 mm.

Filters should be replaced when the final pressure drop is reached. If the air is relatively clean, it can take a long time before this happens. For hygienic reasons, we therefore recommend replacing the filters at least once each year e.g. after the summer, when the season for pollen and other micro biological pollutants has ended. Then you can have a relatively clean filter for a long time.



## Fine filters

---

Fine filters are composed of thinner fibres than the wide-meshed filters and have the ability to collect impurities all the way down to submicron particles. Small particles are generally regarded as more harmful to health than the larger ones.

Fine filters are available as bag filters and compact filters. Bag filters have a large filter surface which is advantageous with regard to both the pressure drop and the collecting efficiency. The compact filter is an alternative when the space for the filter is limited. It is a tightly pleated filter mounted in a frame. In spite of the compact filter's short overall length, its tight pleating in combination with its fine filter material provides a relatively large filter surface and an acceptable pressure drop.

In most cases, class F5 – F7 particle filters provide a good protection against the fouling of air handling units,



Bag filter



Compact filter

supply air ducts and rooms. In urbane environments where the outdoor air is substantially polluted by vehicle traffic, a class F8 or F9 fine filter made of micro glass is recommended on the supply air side.

## High efficiency HEPA filters

---

High efficiency HEPA - filters are used when extremely clean air is required. These filters contain of a thin and very tight and deeply pleated filter paper having a fibre diameter of approx.  $1 \mu\text{m}$ , tightly fit in a frame of wood or metal. The flow area can be more than 70 times larger than the face area, which makes the air velocity through the material low.

This is advantageous when it comes to pressure drop and collecting efficiency.

The filters still have, compared with fine filters, relatively high pressure drops, but in a well-made installation with pre-filtration, the pressure drop with time will only marginally increase.

Because these filters are so exclusive, they should be protected by pre-filters and fine filters of high class, so that they can be utilized for many years. Such filters are used when it is economically motivated to protect these with pre-filters, e.g. of class G3.



Normally long filters should be selected since they offer the best total economy. Short filters should be selected only if there is a shortage of space. HEPA – filters with sheet-steel frame can manage 100 % air moisture, but must not become wet.

## Carbon filters

---

Carbon filters and chemical filters remove cooking odours from fast-food bars, reduce vapour from aviation fuel at airports and remove corrosive and other harmful substances from the air in archives and museums etc.

The useful product life of a carbon filter is difficult to predict. It depends on air flow, the concentration of pollutants in the air, which most often is not known too well, and how much carbon is in the filter bed. It can also be difficult to determine when the service of a carbon filter has ended. After a time the filter may work so that it mostly collects peaks in the concentration, while low concentrations, which earlier were separated, are allowed to pass through the filter. Carbon filters with impregnation (chemical filters) can be tailor made for cleaning where traditional carbon filters are useless.



---

## Installation

It is desirable that the airflow is uniformly distributed across the inlet face area of a filter. Abrupt duct bends upstream of filters should be avoided. Outdoor grilles and air intake ducts should be designed to minimize the risk of the filter becoming wet. In coastal areas, filters may still become wet due to a long-lasting fog, which is sucked in through the air intake. In such cases, a stainless drip tray should be placed below the filters to prevent the bottom of the unit from corroding.

Units with heat exchanger should be protected with filter also on the extract air side.

To ensure the longest possible useful product life for high efficiency HEPA filters and carbon filters, they should be protected by at least class F8 micro glass filters. High efficiency filters must be installed on the pressure side of the supply air fan, or if required on the suction side of the extract air fan. Where extremely toxic or potent substances could be expected in the extract air, the filters should be installed in so-called "safe trans-

formation cabinets" and not in the air handling unit. Sufficient open space should be arranged in front of units that contain filters to enable filter replacement on the upstream side and measurements on the downstream side.

It is important to incorporate filters into the air handling unit in a way that will minimize any by-pass leakage. This is especially important for filters with high collecting efficiency.

CEN notes a limit where the by-pass leakage for F and G filters may reach up to at least 10 % of the penetration. This includes the infiltration between filter and fan. Class F8 and F9 filters should therefore be installed on the pressure side of the fan, so that no air can leak into the unit downstream of the filter.

For high efficient filters with collecting efficiencies to the order of 99.99 %, the by-pass leakage must be extremely small.

## Summary



The air is cleaned from pollutants with filters. There are particle filters for cleaning of particulate pollutants and carbon filters for gaseous pollutants. Ordinary pollutants are dust particles, micro organisms and residual products from traffic, combustion and industry.

The active material in a particle filter is a layer of thin fibres of micro glass or synthetic material (plastic). Carbon filters consist of activated carbon sometimes with chemicals added.

Particle filters are divided into different groups: Wide-meshed filters, Fine filters and high efficiency HEPA filters. Testing procedures and classification within each group is described in the EN 779 Standard for wide-meshed filters and fine filters and in the EN 1822 Standard for the high efficiency filters.

Today there is no European standard for the testing and classification of carbon filters.

Small, light particles follow the air around the filter fibres. If they come close enough, they are attracted to the fibres and stick to them.

Particle collection in particle filters takes place by means of four physical mechanisms and for certain filters an electrostatic particle collection also takes place.

The four physical mechanisms are: the Strainer effect, Interception effect, Inertia effect and Diffusion effect.

The strainer and inertia effects are dominant for larger particles, whereas the diffusion effect is totally dominant for the submicron particles. The electrostatic separation effect is only available in connection with synthetic filters.

For general ventilation in most cases it is enough with a supply filter of class F7.

In sensitive indoor environments close to heavy vehicle traffic, at least filters of class F8 are recommended. In order to ensure a long useful product life for high efficiency filters and sorption filters, these filters should be protected by fine filters of at least class F8 rating. The filter should be made of micro glass.

# 12

## Sound attenuators



### The chapter deals with the following

- Absorption sound attenuation
- Reactive sound attenuation
- How the width and length of the sound absorber influence the sound attenuation
- Pressure drop
- Sound generation from the sound absorber
- Location
- Measurements

Obviously the function of a sound absorber is to reduce the sound level. How this is done and which parameters determine the sound attenuation requires a little bit more understanding. Regardless of whether a sound absorber is mounted in an air handling unit or in a duct, the basic function is the same. Even components which are not called sound absorbers may have a sound attenuating function and follow the same physical principles as a sound absorber.

## Sound attenuation

It is a physical fact that energy can not be destroyed. When we talk about sound attenuation we mean that the sound is either converted to heat, or that the sound energy is moved to areas where it does less damage.

## Absorption sound attenuation

As a technical term, we use absorption or resistive sound attenuation when sound energy is converted to heat. When a sound wave passes through an absorbent, besides the air molecules, the fibres or porous walls of the absorbent also move. The friction in the fibre converts vibration energy to heat. An open fibrous or porous structure provides the highest and, in frequency, widest possible absorption.

To prevent the fibres from detaching and being entrained by the airflow, we can place a staple fibre cloth, for example Cleantec, onto the surface of the absorbent. The principal for an absorption sound absorber is shown in the figure below.

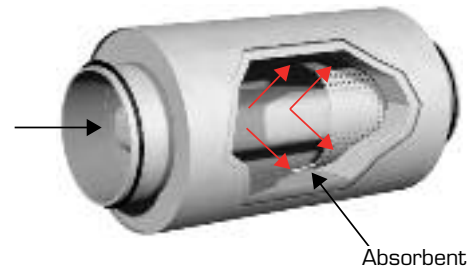

Basic principle of the absorption sound absorber

To further increase the absorption sound attenuation, baffle elements can be positioned in the centre of the sound absorber. The principle for the sound attenuation in baffle elements is the same as for other absorbent material in sound absorbers.

## Reactive sound attenuation

Reactive sound attenuation implies that the sound energy is reflected or is obtained in resonance. The principle for reflection sound attenuation is shown in the figure below. On a change in the duct area, a part of the sound energy will be reflected back and in this way decrease the sound level downstream of the sound absorber. A bend or an elbow in the ducting as well as an air terminal device in the room will also create reflection and in this way attenuate sound.

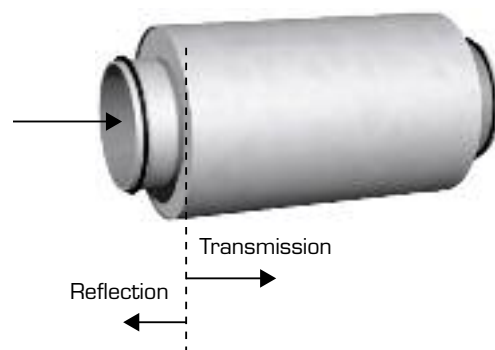

Basic principle of the reflection sound absorber



An indirect way to attenuate sound is to let it leak out of the system. A duct wall has a limited sound attenuation and leaks sound to its surroundings. The disadvantage with this type of sound effect distribution is of course that also the room, in which the the duct wall is situated, may have sound requirements to be complied with.

## Width

A wider sound absorber has two advantages. Depending on duct diameter there is scope for a large area difference between duct and the sound absorber.

The larger this difference is the higher the reflection will be and also the sound attenuation.

The figure below gives an example that explains the effect of this change in diameter. Every curve in the graph illustrates the sound attenuation for a sound absorber with the area relationship between the sound absorber and the duct given in the figure.

For example the area of the sound absorber is four times larger than the duct area for  $m=4$ .

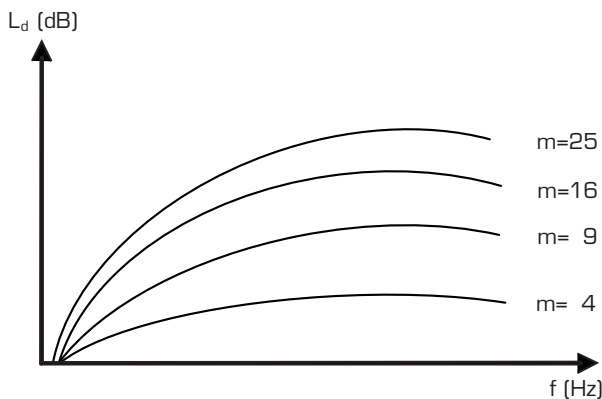

Sound attenuation ( $L_d$ ) as function of frequency and area change. The relationship between sound absorber area ( $A_d$ ) and the duct area ( $A_k$ ) is denoted by  $m$  in the figure ( $m=A_d/A_k$ ).

The other advantage of a wider sound absorber is that it has more space available for absorption material and this increases the sound absorption. Thus it is advantageous to select a sound absorber that is as wide as possible, if the installation space allows it.

## Length

Increasing the length of the sound absorber makes sound attenuation possible at lower frequencies. The disadvantage of this is that a long sound absorber introduces more resonances in the higher frequencies. The figure below gives an explanatory example involving three sound absorbers of different length, where sound attenuation, as a function of frequency, is presented in the graphs.

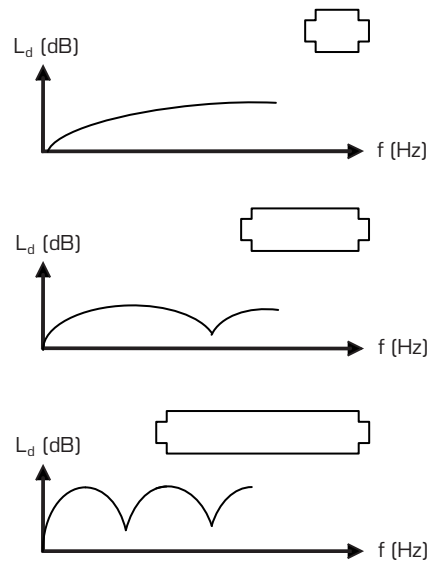

Increasing the length of the sound absorber increases the sound attenuation ( $L_d$ ) in the lower frequencies but introduces resonances.

If sound attenuation is required in the low frequencies, a long sound absorber can be appropriately selected. A longer sound absorber gives, as in the case with a wider sound absorber, access to a larger volume of sound absorption material and an increased absorption sound attenuation.

## Pressure drop

The selection of a sound absorber is always a trade off between sound attenuation and pressure drop. If we can tolerate a higher pressure drop, then we have more scope for improving the sound attenuation. It is especially important to consider the pressure drop, when designing the baffle elements for the sound absorber.

The figure below shows the baffle elements in a sound absorber. It is important to find balance between the size of the baffle elements (A) and the free surfaces (B), which allow the air to flow through the sound absorber. If the baffle elements are too large, not only will the sound attenuation increase; the pressure drop and sound generation will increase as well. Baffle elements are often designed with rounded front edges and with a tapered shape in the direction of air flow to minimize the pressure drop.

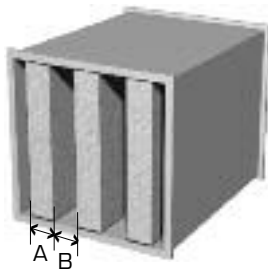

Rectangular sound absorber with baffle elements.

## Sound generation

The lowest sound level possible that can be achieved downstream of a sound absorber is conditional on how much natural sound / regenerated sound is produced by the sound absorber. When air flows through the sound absorber, it generates sound. Regardless of the sound level upstream of the sound absorber, this sound level will be the lowest possible one downstream of it. If the air velocity increases, the level of regenerated sound will increase. Due to the effect of natural sound, it is not certain that two sound absorbers, one behind the other, will provide better sound attenuation than only one sound absorber would provide. The sound generation of a sound absorber is sensitive to how well the baffle elements have been mounted. If a gap arises at the upper edge of the baffle element, this may impair the sound attenuation and may generate whistling sounds.

## Location

Generally a sound absorber should be located as close to the sound source as possible. The reason for this is that the difference of level between the sound to be silenced and the natural sound level of the sound absorber

will be the largest there. Therefore the sound attenuation does not risk drowning in the natural sound. A certain distance must be kept to a component that creates turbulence, for example a fan. In order for the sound absorber to operate optimally, the airflow should be uniform. If the distance is too short, the airflow has not regained a uniform flow characteristic and the sound attenuation will not come up to specified performance. Also the pressure drop across the sound absorber will increase if the air flow is too uneven. The sound absorber should therefore not be installed directly connected to a fan, bend, damper or other component, which may disturb the airflow. If two sound absorbers are used together, they should be placed at a distance from one another. The figure below shows the principle on how the sound attenuation is influenced by the distance. It is above all the low frequency sound attenuation that decreases if the distance between them is too short.

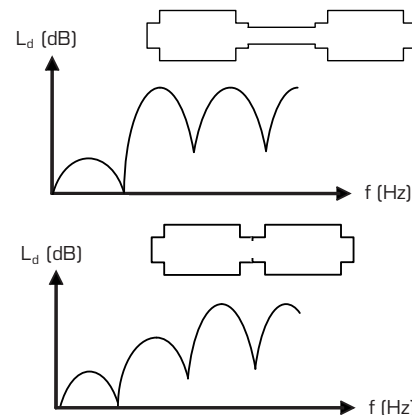

Sound attenuation ( $L_d$ ) will decrease if two sound absorbers are placed at too short a distance between them.

## Method of measurement

The sound attenuation specified by the manufacturer should be measured to EN ISO 7235 or EN ISO 11691. The standard indicates how a sound source or flow source, such as a fan, should be connected to the sound absorber. The sound attenuation is measured as the difference between a system with or without sound absorber. A substitute duct is used when the sound absorber is not to be mounted. Besides sound attenuation, the manufacturer should specify pressure drop, dimensions, weight, selection of material and information regarding installation and maintenance.

## Summary



The function of a sound absorber is to reduce the sound level. The basic function of a sound absorber is the same regardless of whether it is located in a unit or in a duct.

When we talk about sound attenuation we mean that the sound either is converted to heat or that the sound energy is moved to areas where it does less damage.

As a technical term, we use absorption or resistive sound attenuation, when the sound energy is converted to heat. When the sound wave passes through an absorbent, the fibres or porous walls of the absorbent also move. The friction in the fibre converts vibration energy to heat.

Reactive sound attenuation implies that sound energy is reflected or is obtained in resonance. On a change in the duct area, a part of the sound energy will be reflected back and in this way decrease the sound level downstream of the sound absorber.

A wider sound absorber offers two advantages:

- The larger the area difference is between duct and sound absorber, the higher the reflection and the sound attenuation will be.
- The larger volume available for the absorption material increases the sound absorption.

Increasing the length of the sound absorber makes sound attenuation possible at lower frequencies. The disadvantage is that a long sound absorber introduces more resonances in the high frequencies.

The selection of a sound absorber is always a trade off between sound attenuation and pressure drop. If the baffle elements in the sound absorber are too large, not only will the sound attenuation increase; the pressure drop and sound generation will increase as well.

The lowest achieved sound level possible downstream of a sound absorber is conditional on how much natural sound / regenerated sound the sound absorber produces. When air flows through the sound absorber, it generates sound.



# 13

Fans



### The chapter deals with the following



- Centrifugal fans
- Plenum fans
- Axial flow-fans
- Fan charts
- System curves
- Efficiency
- Temperature rise
- Sound
- Natural frequency
- Vibration isolation
- Direct-drive
- Belt-drive
- Fan motors
- SFP

The fan can be regarded as the heart in every air treatment system. It is the fan that makes the air move from the external wall, through the duct system and different air treatment processes.

The simplest systems consist only of a fan, mounted in a wall and which blows air directly into the room. It is evident that the fan must transmit enough energy to the air to overcome the pressure losses and make the air move. A fan consists among other things of an impeller, which in turn consists of a number of blades, which are fastened to a hub. As the impeller rotates, the

blades work with the air so that the air pressure increases. The pressure difference between the fan and e.g. the room at the end of the duct makes the air move.

Normally the impeller is driven by an electric motor.

The fan generates a total pressure rise, which consists of static and dynamic pressure on the air that passes through it.

Since we would like the air to move rather slow in the duct in order to minimize both pressure losses and the sound, we are not interested in generating a high dynamic pressure in the fan. At 10 m/s in the duct the dynamic pressure is about 60 Pa, which is small compared to normal pressure increase across the fan. For this reason, fans are designed so that all dynamic pressure is transformed to static pressure within or by the fan outlet.

## Fan types

Fans for comfort ventilation can be divided into two groups: Centrifugal fans and Axial-flow fans.

In the axial-flow fan, the air passes through the fan in a direction parallel to the shaft of the impeller.

In the centrifugal fan the air enters the fan in a direction parallel to the shaft of the impeller, but leaves it in a direction which is centrifugal (perpendicular) to the shaft.

The plenum fan is a centrifugal fan without spiral-shaped fan casing. All these three fans are ordinarily used in air handling units, but the most common ones, at least in Europe, are the centrifugal fan and the plenum fan (i.e. fans with the centrifugal fan impeller).



Plenum fan



Centrifugal fan

## Centrifugal fans

---



The purpose of the fan's spiral formed casing is to transform dynamic pressure to static pressure.

### **Centrifugal fan with forward-curved blades**

The centrifugal fan with forward-curved blades creates most dynamic pressure in the impeller and the spiral form of the fan casings is essential for its function. For a given impeller diameter and speed, the fan with forward-curved blades however generates the highest pressure and therefore enables the most compact design for a given pressure.

In relation to the size of the fan it also supplies a substantial flow. The fan with forward-curved blades is inexpensive to manufacture, which has contributed to why it is so popular in the air conditioning industry. The main disadvantage of the fan with forward-curved blades is its relatively low efficiency and maximally limited top speed, which makes it unsuitable for larger airflows. Its specific sound is also rather high. The centrifugal fan with forward-curved blades is commonly used in small ventilation systems at low cost. In a fan chart for a centrifugal fan with forward-curved blades, you can see that the speed curves are flattened and the operation is usually stable throughout the whole working range.

When we throttle such a fan that is operating at con-

stant speed, this decreases the air flow and the power required without especially changing the pressure no special change of pressure. This implies that a simple air damper can effectively be used for regulation.

The form of the power curves tells us that the efficiency will increase when the flow increases. Large pressure losses in the system can lead to the motor becoming overloaded.

### **Centrifugal fan with backward-curved blades**

The backward-curved impeller consists of several blades, which form centrifugal diffusers. Static pressure is generated when the air flows through the impeller and the fan casing is not as important as it is for the forward-curved impeller type, yet it has the same diffusing function and gives the fan high efficiency.

An impeller with backward-curved blades must be rotate twice the speed of an impeller with forward curved impeller of same diameter in order to obtain the same pressure and flow. The backward-curved blades also provide high efficiency and the robust design allows higher max speeds than the centrifugal fan with forward-curved blades.

Centrifugal fans with backward-curved blades have a relatively low specific sound level. In the fan chart you can see that the fan curves are steep, which means that the pressure changes in the system have comparatively little effect on the airflow. We see from the form of the power curves that a fan running at constant speed will not overload its motor if the pressure in the system changes.

Centrifugal fans with casing are most often operated by motor via a belt drive. The belt transmission is dimensioned for each combination in order to achieve the desired speed.

Centrifugal fans with fan casing require an empty length of straight duct downstream of the fan, because it has a smaller outlet area. This leads to the need for an empty straight stretch for the air to have time to distribute it-self uniformly in the unit, before it reaches the next functional section.

## Plenum fans

---



The plenum fan has a single inlet impeller with backward-curved blades but has no fan casing. Its performance is similar to that of the centrifugal fan with backward-curved blades, but with no advantage of the static pressure recovery in the fan casing.

The advantage of using plenum fans is that they are direct-driven and lack drive belts, which otherwise would require maintenance. This makes plenum fans more hygienic because they do not have any belts which can give off dust. The open design of the plenum fan allows simple access for service and cleaning.

The direct drive which means that the impeller is mounted directly on the motor shaft makes it possible to balance the fan to low levels.

In order to obtain different rotational speeds the fan motor must be speed controlled by means of a frequency exchanger for example, see fan chart for plenum fans further in the chapter. Belt-driven plenum fans are available on certain markets.

Another advantage with the plenum fan is that you can install a subsequent function such as air heater or cooling coil directly downstream of the fan.

## Axial-flow fans

---



Axial-flow fans produce relatively large airflows at low pressures. The larger fan diameter and rotational speed, the higher the pressure will become. Centrifugal fans have a fixed geometry and performance and therefore can only be changed by changing fan speed.

Axial-flow fans on the other hand can have different hub diameters and number of blades. Hereby it is also possible to select level as well as speed. For this reason, axial flow-fans are commonly direct-driven.

Axial-flow fans which are equipped with guide vanes downstream of the outlet have high efficiency. In order to obtain normal pressures like those in air handling units, axial-flow fans must operate at high speed.

This is why they are not appropriate for use in small air handling units, since the diameters in question, mean that high rotational speeds are required. You can see in the fan chart that axial-flow fans have steep speed curves and flattened power curves with higher power requirement for low flows.

This means that more power is required when you throttle the axial flow-fan to a very low flow.



# Fan chart

The performance of the fan is normally shown in the form of a chart with airflow drawn on the longitudinal axis and the pressure on the vertical axis.

For centrifugal fans, the curves have been drawn for different rotational speeds, whereas for axial flow-fans, the curves have been drawn for different blade angles. There are also curves for efficiency and sound level, as well as curves for fan power drawn in the charts.

In the centrifugal fan chart below, total pressure increase is shown as  $\Delta p_t$ , Pa and the shaft power of the impeller  $P$ , kW is shown as a function of the airflow  $q_v$ ,  $m^3/s$  and for a number of fixed fan speeds. Furthermore a number of duty lines are shown along which the efficiency is constant.

A-weighted sound power level is shown in the chart as

$L_{wA}$ , dB to the fan outlet. The sound power per octave band  $L_w$ , dB (not A-weighted) to the outlet, to the inlet side and to the surroundings through the unit casing can be calculated using the correction values, which are specified in the chapter dealing with acoustic calculations.

To facilitate the selection of motors on centrifugal fans, there is a  $P_M$ , kW, which indicates the minimum permissible motor power with regard to fan power, belt transmission loss and starting time. When it comes to fans with F-impellers (forward-curved blades), this refers to fan power in the duty point, whereas for the type B-fans (backward-curved impeller blades) this refers to the max. value of the power curve at the current speed.

The charts also contain scales for dynamic pressure in the fan outlet,  $p_d$ , and the installation and connection losses  $\Delta p_a$  and  $\Delta p_b + p_d$ .

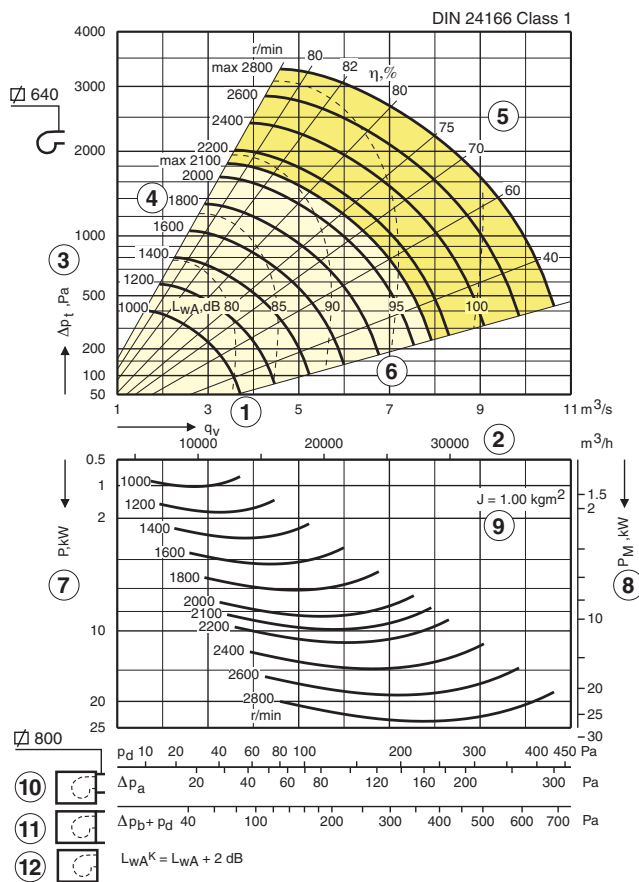

Fan chart for centrifugal fan with backward-curved blades

The fan chart is applicable to air with the density of  $1,2 \text{ kg/m}^3$ .

Symbols used:

- ① = Airflow,  $m^3/s$  (longitudinal axis)
- ② = Airflow,  $m^3/h$  (longitudinal axis)
- ③ = Total pressure rise, Pa (vertical axis)
- ④ = Fan speed, r/min (RPM)
- ⑤ = Fan efficiency, %
- ⑥ = Sound power level,  $L_{wA}$ , dB (dashed line)
- ⑦ = Power demand of the fan,  $P$ , kW
- ⑧ = Power output of the motor,  $P_M$ , kW
- ⑨ = Moment of inertia of the impeller,  $kgm^2$
- ⑩ = Pressure drop across standardised outlet duct,  $\Delta p_a$ , Pa
- ⑪ = Connection loss for connection to air handling unit,  $\Delta p_b$ , Pa
- ⑫ =  $L_{wA}^K$  sound power level of fan in casing

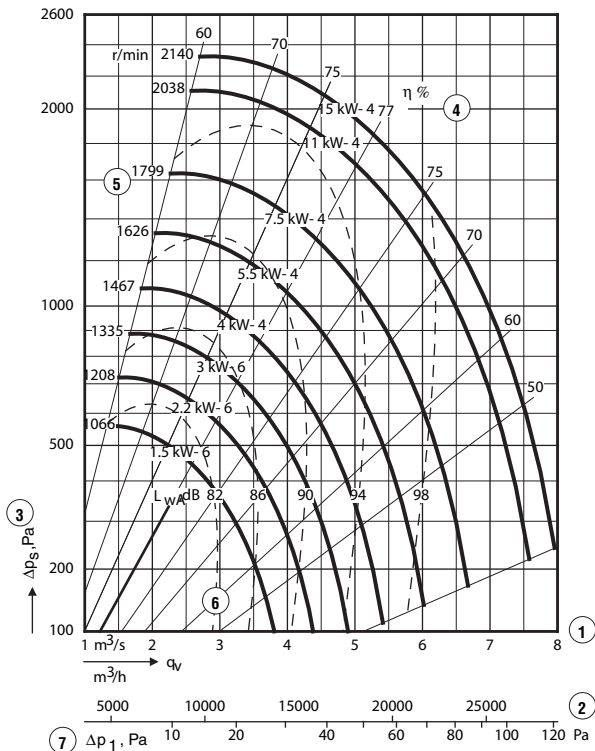

Fan chart for plenum fan

The fan chart is applicable to a "naked" fan and to air with the density of 1.2 kg/m<sup>3</sup>. An incorporation loss  $\Delta p_1$  arises for incorporation into a unit section.

The fan curves in the fan chart show max. speed for combinations of fan and motor size.

- ① = Airflow, m<sup>3</sup>/s (longitudinal axis)
- ② = Airflow, m<sup>3</sup>/h (longitudinal axis)
- ③ = Total pressure rise,  $\Delta p_s$  Pa (vertical axis)
- ④ = Total fan power,  $\eta_{stat}$  %
- ⑤ = Max. speed of each motor, kW-potlalt
- ⑥ = Total sound power level,  $L_{WA}$  (dB), dashed line
- ⑦ = Incorporation loss  $\Delta p_1$  Pa

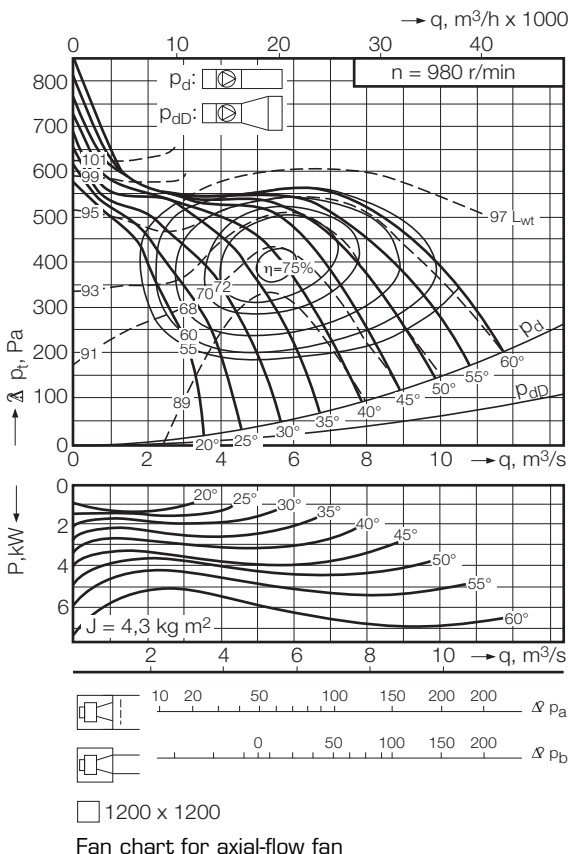

Fan chart for axial-flow fan

## Fan laws

Recalculations in response to changed speed for the same fan and system curve.

$$\text{Air flow } \frac{q_1}{q_2} = \frac{n_1}{n_2}$$

$$\text{Pressure } \frac{\Delta p_1}{\Delta p_2} = \left(\frac{n_1}{n_2}\right)^2$$

$$\text{Power } \frac{P_1}{P_2} = \left(\frac{n_1}{n_2}\right)^3$$

Where

$q$  = Airflow, m<sup>3</sup>/s

$n$  = Speed, r/min

$p$  = Pressure, Pa

$P$  = Power, kW

# System curves

## Compatibility between fan and system curve

Fan curves have different shapes depending on the type of fan. The system curves can also vary, see below. There is no normally problem as long as there is a simple and clear point of intersection between the curves. The fan will operate at the point of intersection, see the chart below.

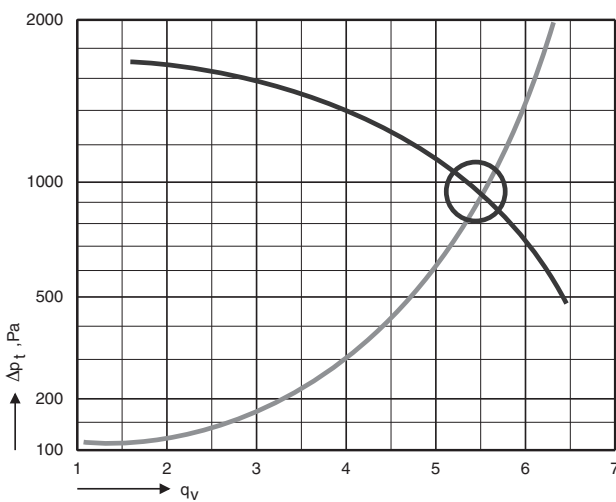

Intersection between fan and system curve

If the fan curve intersects the system curve at two points, this can lead to problems, see the chart below.

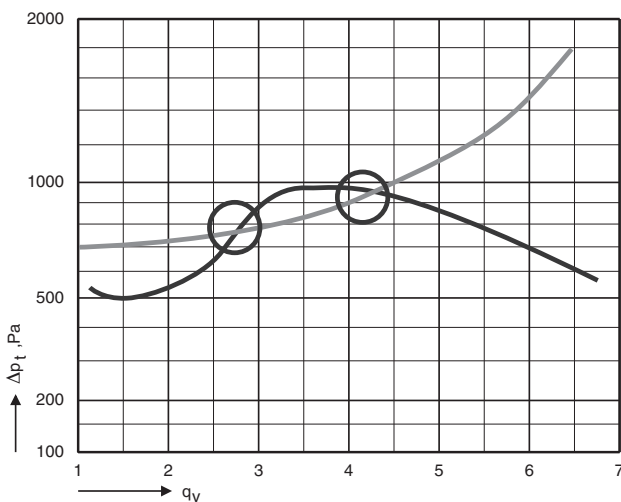

Fan curve intersects the system curve at two points

This problem normally arises only with fans that have flattened curves with a “saddle” such as fans with forward-curved blades operated for a system with a high constant of pressure and no airflow.

## Effects of changed system characteristic

The system characteristic for a normal duct system follows the following relationship:

$$p = p_0 + k \cdot q^n$$

Where

$p$  = Pressure, Pa

$p_0$  = The pressure at zero flow,  
the constant pressure, Pa

$k$  = the system constant

$n$  = system exponent, which normally is close to 2.

Generally, the value of  $n$  will not vary in a normal system. Usually  $n$  will be 2 for almost all components within the system, however where laminar flow occurs, the value of  $n$  will be less than 2. The filters and some types of heat exchangers have such a characteristic.

The effect on these sections in the system is to reduce the total value of  $n$ . This effect may become of importance in systems which involve high levels of filtration, such as clean room applications.

The value of  $k$  can change if for example a damper setting is changed or as the filters become clogged. In a simple system, the filters are the main cause of pressure change, when they become fouled, this increases the pressure drop. Fans are usually driven by totally enclosed, 3-phase squirrel-cage induction motors, which work mainly at constant speed independent of the load. This means that the duty point of the fan must move along the speed curve when the pressure changes. This is illustrated in the chart below.

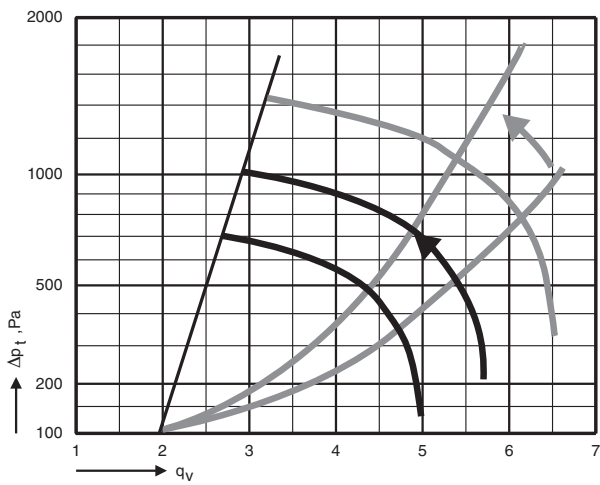

The duty point of the fan moves along the speed curve (centrifugal fan with forward-curved blades)

Here we see that as the pressure drop in the system increases; the duty point moves towards left along the fan curve. Note that the airflow reduces.

The figure below represents a centrifugal fan with forward-curved blades with its flattened characteristic. Here we see that the flow reduction becomes much greater.

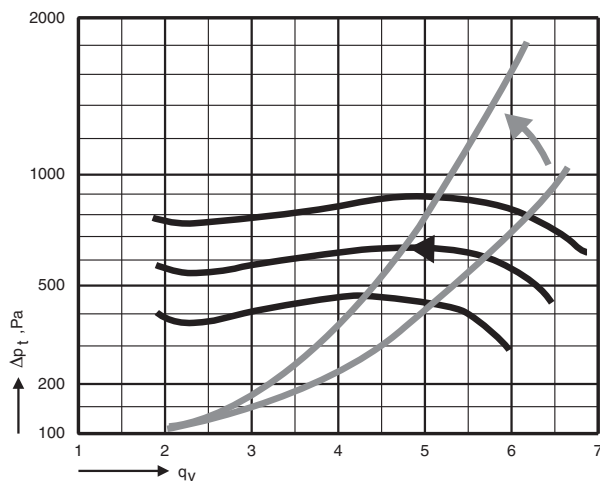

The duty point of the fan moves along the speed curve (centrifugal fan with backward-curved blades)

## Parallel operation of fans

When two fans are operated in parallel, the achieved pressure remains unchanged, but the flow is doubled. The combined curve is much flatter than the individual curve and if more than two fans are operated in parallel, the curve can become extremely flat. No problems normally occur if both fans start at the same time, provided that the duty point is well to the right of the maximal point.

Fans with a characteristic like the one below to the left, a centrifugal fan with forward-curved blades can however generate the same pressure at two different flows. Duty points to the left of the maximal can give increased instability, reduced flow and even reversed flow through one of the fans.

Normally this should not happen, but it can happen if the system is extremely throttled or if the fans have been oversized.

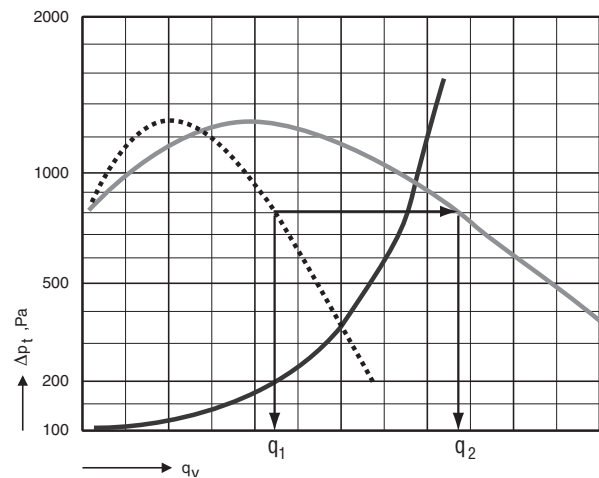

Same pressure at two different flows

## System effects

Pressure losses caused by unfavourable duct design downstream of the fan outlets are called system effects. The high outlet speed and the lack of symmetry are the causes of the system effect.

The velocity profile develops to a normal velocity profile, after 2.5 times the duct diameter at velocities up to 12 m/s. This length is known as effective duct length.

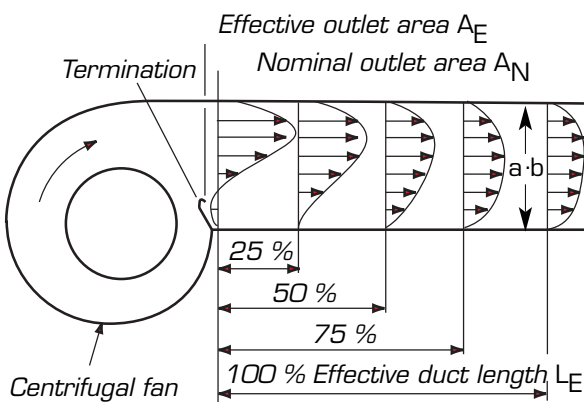

System effects

## Duct bends

A duct bend connected immediately downstream of the fan outlet will give rise to a system effect. Here the lack of symmetry in the velocity profile is the cause. For double-inlet fans used in air handling units, the system effect caused by left-hand and right-hand bends is the same. Plenum fan sections incur no loss due to a duct bend.

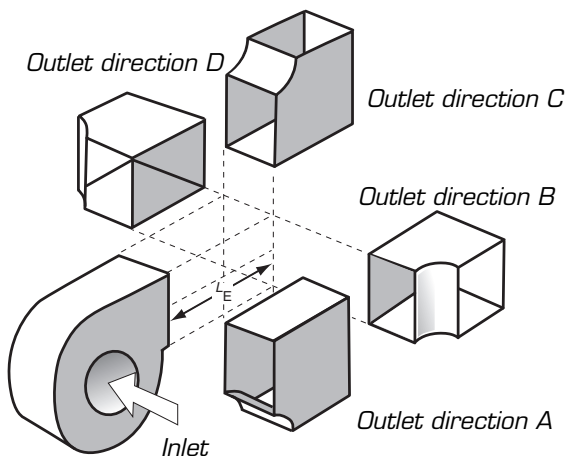

Duct bends

## Louvre damper

A louvre damper fitted to the fan outlet causes a system effect. The pressure drop will be 5 times greater than the normal pressure drop of the damper.

## Fan efficiency

The efficiency of the fan is defined as the condition between the flow multiplied by the total pressure and the shaft power on the impeller shaft.

$$\eta_f = \frac{P_f}{P_R} = \frac{k_p \cdot q_{vi} \cdot p_{tf}}{P_R}$$

Where

$\eta_f$  = Fan efficiency, %

$P_f$  = Power, W

$P_R$  = Impeller power, W

$k_p$  = Compressibility factor

$q_{vi}$  = The airflow of the fan at the inlet, m<sup>3</sup>/s

$p_{tf}$  = The total pressure rise of the fan, Pa

The compressibility factor can be disregarded when working with fans for comfort ventilation, since the increases in pressure through the fan are so small.

The fan power is drawn in the fan chart.

## Temperature rise through the fan

When the air passes through the fan work is done on it and its temperature rises. The temperature rise is expressed as:

$$\Delta t = \frac{k_p \cdot P_{tf}}{\rho \cdot \eta \cdot c_p}$$

Where

$\Delta t$  = Temperature rise, °C or K

$k_p$  = The compressibility factor which can be disregarded

$P_{tf}$  = Total pressure rise of the fan, Pa

$\eta$  = Fan power

$\rho$  = Density of the air, kg/m<sup>3</sup>

$C_p$  = Specific heat factor

As rule of thumb, we can estimate  $\rho = 1.2$ ,  $\eta = 0.80$

and  $C_p = 1008$  and therefore

$\Delta t \approx P/1000$  or 1°C per 1000Pa.

Note that the heat generated by the drive motor of the fan does not have anything to do with this temperature increase!

Most fans in air handling units are installed with drive motor and belt drive inside the casing and in addition to the above-mentioned temperature rise, the inefficiency in motor and belt transmission will further increase the temperature.

$$\Delta t = \frac{k_p \cdot p_{tf}}{\rho \cdot \eta_f \cdot \eta_m \cdot \eta_{tr} \cdot c_p}$$

Where

$\Delta t$  = Temperature increase, °C or K

$k_p$  = Compressibility factor which can be overlooked

$p_{tf}$  = Total pressure rise of the fan, Pa

$\eta_f$  = Fan power

$\eta_m$  = Motor power

$\eta_{tr}$  = Transmission power

$\rho$  = Density of the air kg/m<sup>3</sup>

$c_p$  = Specific heat factor

## Fan impeller balancing

All impellers are dynamically balanced to ISO 1940/1 – 1973.

The following applies to Fläkt Woods fans:

The balance grade for plenum fan impellers is G 6.3 for sizes 022-031.

For sizes 035-100, the balance grade is G 2.5.

Balance grade for double-inlet impellers is G 6.3 for sizes 022-031.

For sizes 035-100, the balance grade is G 2.5.

## Natural frequency

Every oscillating object has a natural frequency, which is the frequency that an oscillating object tends to compensate if it is not disturbed.

The phenomenon where a relatively small, repeated given power causes the amplitude of an oscillating system to become very large is called resonance.

Many of the serious vibration problems are caused by resonance.

If, for example, the natural frequency of a car chassis

coincides with the engine speed, the chassis can vibrate.

Such vibration can be avoided by mounting the engine on a flexible material such as rubber, in order to isolate the chassis from the motor. The same thing of course applies to fans.

## The natural frequency of the anti-vibration mountings

The vibration isolation on Fläkt Woods' fans is sized so that the incorporation frequency/natural frequency is lower than 8 Hz or 480 RPM with rubber anti-vibration mountings and 4Hz or 240 RPM with steel spring anti-vibration mountings.

## Permissible vibration velocity

A complete fan unit containing fan, motor, belt transmission and base frame, mounted on anti-vibration mountings, is permitted to have a vibration velocity of max 7.1 mm/sec.

The vibration measurement should be carried out on the bearing support arms and on the motor bearing plates.

## Sound

A-weighted sound power levels  $L_{WA}$  on the outlet side of a fan for connecting the ducting is specified in the fan chart. The following formula can be used for breaking down the sound into each octave band and sound path:

$$L_{W_{okt(s)}} = L_{WA} + K_{okt(s)}$$

Where

$L_{W_{okt(s)}}$  = Sound power level per octave band, dB

$L_{WA}$  = A-weighted sound power levels, dB

$K_{okt(s)}$  =  $K_{okt}$  is a factor for correcting every single octave band depending on the speed of the fan.

Read more about fans and sound in chapter on Sound.

# Vibration isolation

The purpose of vibration isolation is to protect the supporting floor from forces generated by the fan. The principal force is generated by the unavoidable residual imbalance in the fan rotor.

The anti-vibration mountings can be used to effectively prevent the imbalance forces from propagating to the supporting floor. The isolating effect of all anti-vibration mountings fortunately improves as the frequency increases, and the force that is transferred by the anti-vibration mountings will therefore continue to be low, even at high fan speeds.

This relationship is clearly illustrated in the figure below, where the transferred force,  $T$ , as a percentage of the weight of the fan rotor,  $R$ , is plotted as a function of the fan speed for rubber and steel spring anti-vibration mountings with various spring deflections.

If the fan is equipped with soft steel springs, problems can arise when the fan is started up, since the reaction force from the airflow causes the fan to tip out of line.

This can cause a sharp pressure drop, further noise and transfer vibration from the fan to the duct system, through the flexible connection between fan and unit. Violent fan movements can also lead to wear in the flexible connection and eventual breakage.

Experience has shown that it is important to ensure that the floor has sufficient area and mass to avoid resonance.

**The following rule of thumb can be used:**

The floor with a surface that is 4 times the surface of the unit, should have a mass that is equivalent to at least 5 times that of the unit.

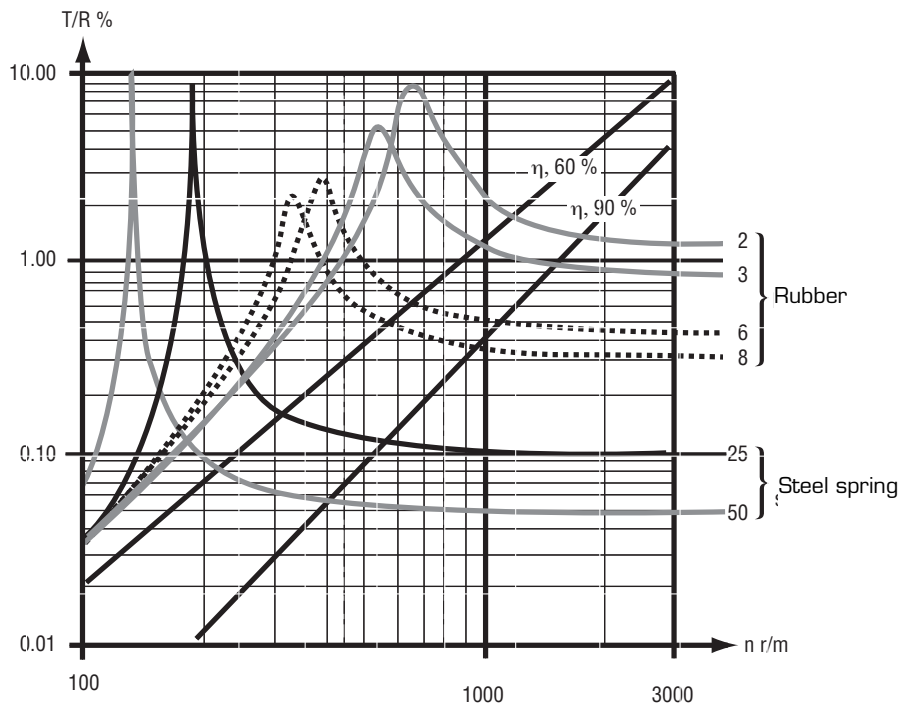
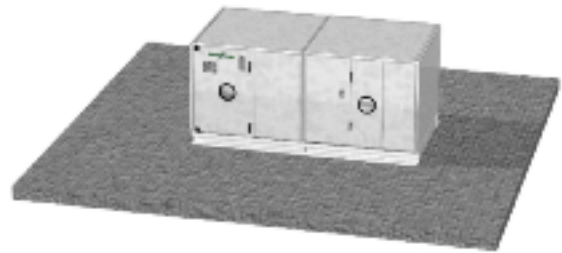

Vibration attenuation

## The drive system of the fan

Fans can either be direct-driven and are then mounted on the motor shaft, or they can be connected to the motor by means of a drive system.

### Direct drive

Direct drive refers to an arrangement where the impeller is mounted directly on the motor shaft or as on an external rotor motor or flat armature motor, where it is mounted on the rotating outer section.

Direct drives require minimum maintenance and avoid the frictional losses and dust treated by belt drive systems but the impeller speed will be the same as the motor speed.

Most axial flow-fans however have either adjustable or controllable blade angle, which allows the operator to adjust the duty point. Centrifugal fans however do not have adjustable blades and the duty point must be adjusted by regulating the motor speed.

The most common method is to adjust the motor speed by means of a frequency inverter. The energy gains we obtain by avoiding a transmission system may unfortunately be lost in the frequency inverter, since the efficiency of the unit is a function of the load on the motor / frequency inverter.

Direct drive cannot, with the exception of very small fans, be used on double inlet centrifugal fans.

The long fan shaft that would then be required would be subjected to critical flexural oscillations.



Plenum fan with direct operation



# Belt drive system

## Belt drive operation

By means of a belt drive we can select the fan speed to meet the duty with a three phase induction motor coupled directly to the mains supply and running at constant speed. The belt transmission permits great freedom of motor location, which is important when incorporating it into an air handling unit.

A number of different belt transmission systems are available on the market, the most common ones are V-belt drives.



---

## V-belt drives

V-belts are in the form of a V and are designed to fit on pulleys with uniform grooves. The efficiency for outputs above 3 kW is approx. 95%, but can be much worse at lower outputs.

The pulleys and the belts are easy accessible and their maintenance is simple. Depending on the friction between the belt and the pulley, the belts tend to wear while they are in operation and it is essential to replace them regularly. As the belts wear, they give off dust, which may be entrained by the air into the duct system if there is no filter downstream of the fan. Conventional V-belts also tend to stretch a bit and it is important to retension them in accordance with instructions normally supplied.

## Flat belt drives

Technical advancements within this area now allow us to use belts which do not stretch and wear quite as much. One of these is the flat belt.

The advantages of using flat belts are that they do not become worn, they do not require retensioning after the initial tensioning, they provide better transmission power, have long useful product life (approx. 5 years),

high efficiency (approx. 98%) and insignificant dust generation.

The belt shall not be allowed to stand still in cold conditions and if the fans in the unit start and stop frequently. On the other hand, they work fine if the fans operate continuously.

## MICRO-V or poly-V belt drives

MICRO-V or Poly-V belts are a half-way solution between V-belts and flat belts. They have the disadvantages associated with retensioning of V-belt drives, wear, limited useful product life, maintenance and give off dust, but have somewhat better efficiency than the V-belt.

# Fan motors

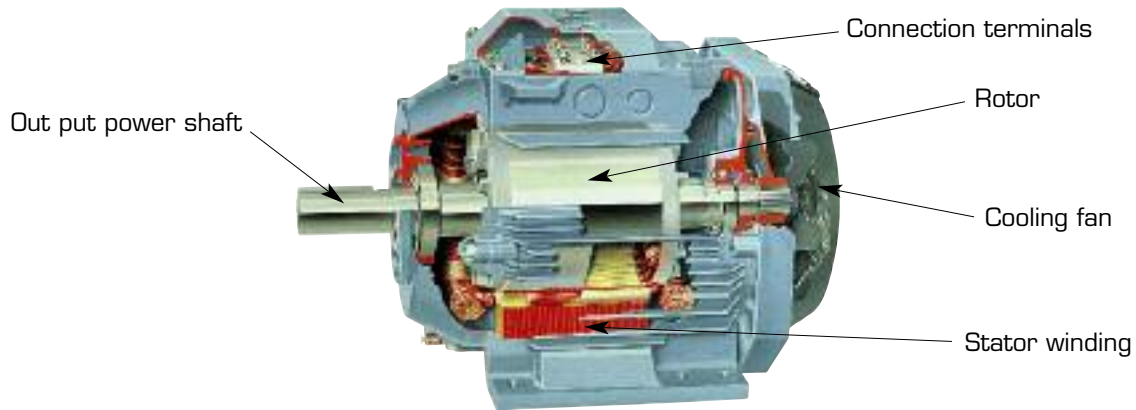

## Three-phase induction motors

In a three phase induction motor, a rotating magnetic flow is generated by copper wire coils. The rotor core is laminated and consists of aluminium rods, which are short-circuited at each end.

An EMF, electromotive force is generated in the rotor conductor. EMF causes a flow to circulate, which makes the flow bend around the conductor and strengthen it on the one side, while it weakens it on the other side. The consequence is that the conductor is exposed to force which makes the rotor spin.

The flow rotates quicker than the rotor. The greater the difference is in speed, the greater the generating EMF and torque becomes. If the rotor should reach synchronous speed, no EMF would be generated and there will be no force to keep it spinning. If the rotor were to slow down in response to the load on the motor, the torque would increase until it was the same as the torque caused by the load and the rotor losses.

The difference between the rotor speed and the speed of the rotating magnetic flow is called slip. Under full load conditions, the slip varies between about 2 % and 7 %, so the induction motor can be practically regarded as a constantspeed machine. The speed at full load is given in motor data charts.

## Torque

The torque curve for a motor is similar to the dashed curve in the charts below. When selecting a motor, the load torque for the motor must be less than minimum torque.

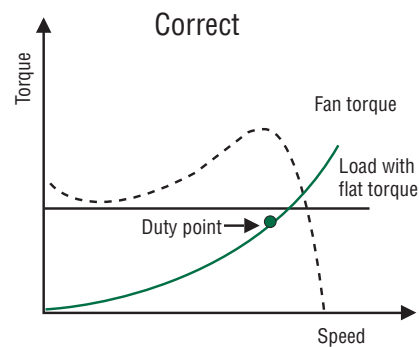
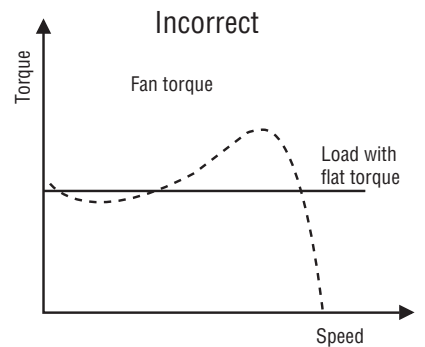

The torque for a motor and load torque

### Power, rotating machines

$$P = M \cdot f$$

Where

$P$  = Power W

$M$  = Moment Nm

$f$  = Frequency Hz

## The motor efficiency

Efficiency is a measurement of how well a motor converts electrical energy into useful work. Energy lost in the process is dissipated from the motor as heat.

## Direct on-line starting of single speed motors

The simplest method of starting a squirrel-cage electrical motor is to connect the mains voltage across a switch to the windings of the motor. Only a direct on-line starter is then needed. However due to the high current when direct on-line starting is employed, there are certain limitations for this method of starting.

Electricity utilities do not usually allow direct on-line starting of squirrel-cage induction motors having rated in excess of 3 – 5 kW. However exemptions can be obtained. If the current-time curve for the overload protection (starter) shows that the motor protection should trip due to the starting time being too long, either a motor with a higher rating or a starter with equipment for heavy starting can be selected.

## Star-delta starting of single-speed motors

Star-delta starting should be employed only if direct on-line starting is not permissible. The motor should then be wound for the mains voltage when in delta connection, e.g. 400 V. The starter used must be a star-delta starter which connects the motor windings in star during the first part of the starting process. For star-delta starting, make certain that the torque curve of the motor in star connection is above the torque curve of the fan up to 90% of the final speed. Due to this requirement, star-delta starting usually demands a motor with a higher rating than that needed for direct on-line starting.

## Start and control of two speed motors

If two-speed control of the fan is employed, the fan is normally driven by a two-speed motor which can be run at two different speeds by pole switching. A pole selector switch is used for starting and switching between two different number of motor poles (speeds).

### **Important!**

Two-speed motors normally cannot be star-delta started. Start the motor at low or high speed.

## Motor protection (overload protection)

The motor protection is designed to protect the motor against harmful overcurrents. The protection is incorporated into the motor starter. Excessively high motor current heats up a bimetallic switch causing it to trip and open the circuit, interrupting the power supply to the motor.

## Equipment for heavy Starting

Starting of a motor with a particularly long starting time may cause tripping of the motor protection during the starting process.

To prevent this, the motor protection can be supplemented with equipment for heavy starting.

## Phase failure protection

A three-phase motor can be damaged by loss of one phase, and the overload protection selected should therefore incorporate phase failure protection.

This device is based on a differential function in the overcurrent relay, which causes tripping in the event of differences between the phase currents, i.e. in the event of loss of one phase.

## EC motors



EC-motors have become a concept in electric motor technology and will have an important role for fan motor operation.

The EC motor is an "electronically commutated" direct-current motor. Commutating in the EC-motor means that the direction of the current in the stator, in relation to the rotor is controlled by a Hall sensor. The direct-current motor is also called DC motor". In traditional DC-motors, commutating takes place mechanically by means of carbon brushes.

Mechanical commutating involves a short useful product life and expensive maintenance. Electronic commutating means that the motor speed can be controlled in a very efficient way.

The motor speed is controlled by how quickly the magnetic fields in the motor change. The permanent magnets of the rotor create the magnetic field inside the motor.

## High efficiency

Efficiency is a measurement on how well a motor converts electrical energy to useful work. Energy losses in the motor are radiated as heat. The EC motor has lower energy losses than an induction motor and so corresponding lower temperature rise.

The chart below shows a comparison of the total efficiency of a type GPEB-031 Plenum fan with EC-motor and induction motor. The total efficiency is based on power input.

Efficiency / tot = efficiency / impeller x efficiency motor x efficiency / controller.

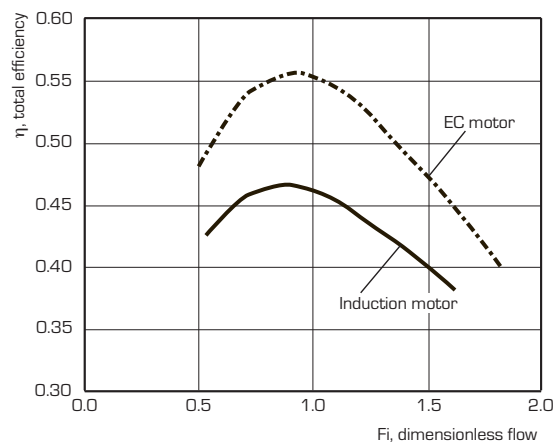

## Speed control

Electronic commutating makes it possible to control the speed of the EC motor in a very effective way. The speed of the motor is controlled by how quickly the magnetic fields in the motor change. No consideration needs to be paid to speeds restricted by a number of motor poles, which is the case with induction motors.

The EC motor has a wide speed range with maintained high efficiency and therefore it is suitable for direct-driven fans. The combination fan and motor can be optimized in its best working range. The EC motor always requires a controller. This can be integrated in the motor or be located as a separate unit. In Fläkt Woods EC motors the control unit is integrated in the motor.

## EC motor characteristics

- Short overall length.
- Smaller physical dimensions in all directions compared with induction motors.
- Low sound generation.
- Low vibrations.
- 1-phase power supply for low outputs.
- 3-phase power supply.

## High-efficiency electric motors

EU and the European motor manufacturing organisation CEMEP have produced a classification and marking system for low-voltage, alternating-current motors according to efficiency classes.

For the time being, the classification applies to three-phase asynchronous motors, 2 and 4 poles, 50 Hz, 400 V and with rated output between 1 and 90 kW.

There are three efficiency classes for these motors: EFF1, EFF2 and EFF3. Class EFF1 being the most energy effective motors.

The chart shows a general overview of the relationship between the classes. Class EFF1 motors should be selected if this option is available.

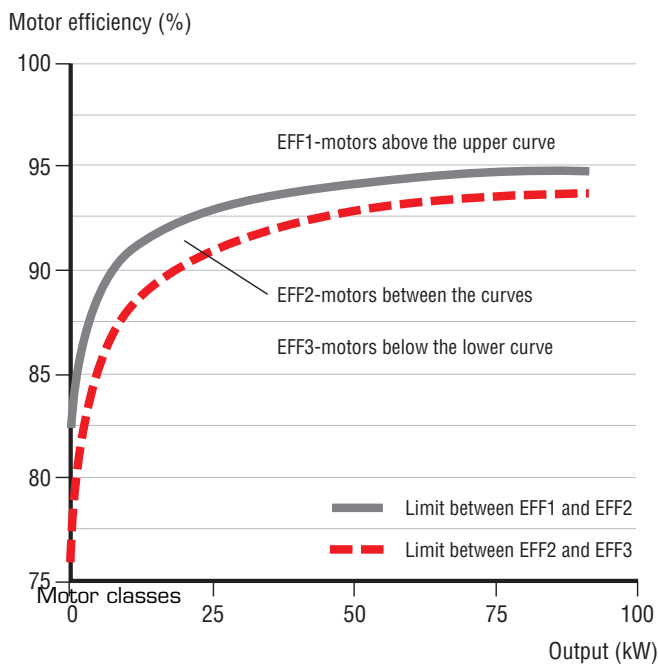

## Starting time – for motors without frequency inverter

The starting time is used for two checks, i.e. that the permissible starting time of the motor is not exceeded and that the motor protection does not trip during the starting process.

### To calculate the starting time:

- Select a motor with rated output,  $P$ , based on the fan's power requirement,  $P_f$ , for a normal duty point, (= open guide vanes/damper).
- In the formula for calculation of the starting time, set the value of  $P_f$  = fan power required for closed guide vanes/damper.

### Use the following formula:

$$t = \frac{J \cdot n_f^2 \cdot 10^{-3}}{46 \left( P \left( \frac{M_{max}}{M} + \frac{M_{st}}{M} \right) \cdot P_f \right)}$$

The calculated starting time is the time for accelerating the fan from rest to full speed.

### To calculate the starting times for Star-delta starting use the following formula:

$$t = \frac{J \cdot n_f^2 \cdot 10^{-3}}{46 \left( P \left( \frac{1}{3} \times \frac{M_{max}}{M} + \frac{1}{4} \times \frac{M_{st}}{M} \right) + P_f \right)}$$

The calculated starting time is the time during which the star-delta starter must be in star connection for the fan to reach approx. 90 % of full speed, where-upon it switches over to delta connection. For star-delta starting, a check must be made to ensure that the motor torque is higher than the fan torque during the star connection phase. *Continued on next page*

**Symbols used**

$P$  = rated output of the motor, kW.

$P_f$  = fan power demand at rated speed, kW (including belt-drive losses).

$PY/D$  = minimum motor rating at which star-delta starting is possible, kW.

$M_{st}/M$  = ratio of motor starting torque to normal torque.

$M_{max}/M$  = ratio of motor max. torque to normal torque.

$n_f$  = rated speed motor, rpm

$J$  = moment of inertia of the system referred to the fan shaft, kg m<sup>2</sup>

The moment of inertia of the fan impeller is specified in the fan chart and the moment of inertia of the rotor can normally be neglected.

## Check of permissible starting time of the motor

The maximum permissible starting time is dependent on the method used for starting and the motor size as well as the number of motor poles and may vary from one make of motor to the next.

## Check of the overload protection device's tripping time

The motor protection tripping time for starting is given graphically by means of current-time curves. The tripping time may vary between from one make of overload protection to the next.

## Motor wiring diagram

### Single speed motor

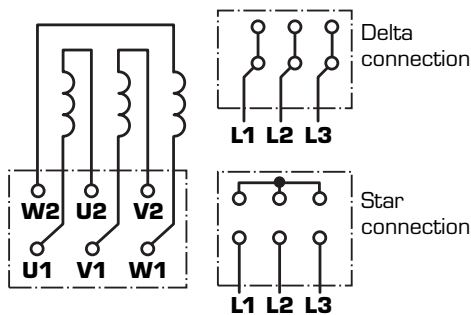

### Two speed motor with one stator winding for pole-switching, so-called Dahlander connection

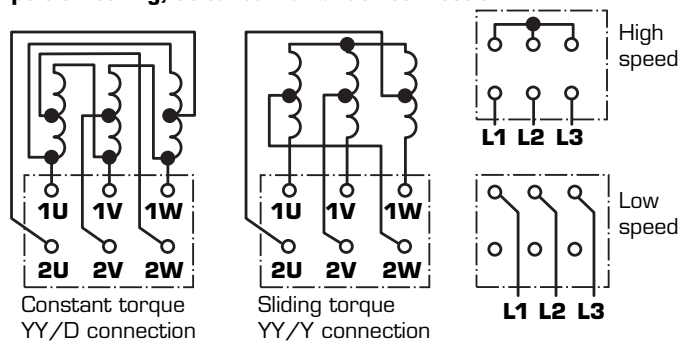

### Two speed motor with separate windings

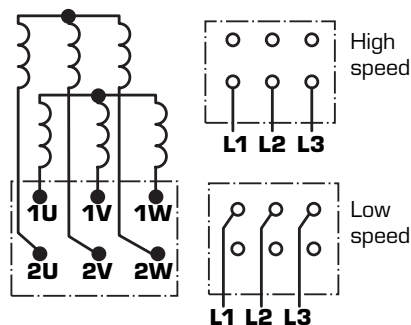

Note that two speed motors with one stator winding for pole-switching, so-called Dahlander connection, have higher power output than corresponding motor size with separate windings.

## SFP value

To obtain a measure of how efficiently the electric power supplied to an air treatment system is utilized, we can calculate the SFP-value (Specific Fan Power) of the air handling unit. The specific fan power, SFP, for an entire building is the sum of the power supplied to all the fans in the building in kW divided by the largest design measurable supply or extract air flow rate in m<sup>3</sup>/s through the building. (Note! Not the outdoor air nor the exhaust air flow rates.)

### Specific fan power output for an entire building

$$SFP = \frac{\sum P_{mains}}{q_{max}}$$

$SFP$  = the specific fan power demand of the building

$P_{mains}$  = the sum of the power supplied to all fans of the building, kW

$q_{max}$  = the largest design measurable supply or extract airflow, m<sup>3</sup> /s through the building

In a CAV system, the SFP flow is rated at 100 % of the design air flow rate, whereas in VAV systems it is rated at 65 % of this air flow rate. The pressure drop that the fans must overcome includes in the pressure drop in the air distribution system and other devices, such as air terminal units, filters and heat recovery systems. System effects should also be included.

## SFP<sub>v</sub>-value

Above, we have described how to calculate the SFP value of the entire building. As we all know, many buildings consist of several different sections, each of which is served by a separate air handling unit. In order to see during the project design work, whether a single air handling unit meets the required partial requirements on energy efficiency, the Swedish Association of Air Handling Industries in V-publication 1995:1 has defined a supplementary SFP value with index "V".

### Specific fan power for a heat recovery air handling unit with supply air and extract air fans

$$SFP_v = \frac{P_{mainsTF} + P_{mainsFF}}{q_{max}}$$

$SFP_v$  = specific fan electric power requirement kW/(m<sup>3</sup>/s) of the heat recovery unit

$P_{mainsTF}$  = Power supplied to the supply air fan, kW

$P_{mainsFF}$  = Power supplied to the extract air fan, kW

$q_{max}$  = The largest supply air or extract airflow through the air handling unit, m<sup>3</sup>/s

The SFP<sub>v</sub> value is calculated with dry coils, clean filters and at an air density of 1.2 kg/m<sup>3</sup>. In order to reduce the energy consumption not only does the pressure in the unit have an effect, the duct pressure is also something to consider. The following guidelines can be used as a simple rule of thumb:

To obtain an SFP<sub>v</sub>=1,5 the duct pressure should be max. 150Pa.

To obtain an SFP<sub>v</sub>=2,0 the duct pressure should be max. 200Pa.

To obtain an SFP<sub>v</sub>=2,5 the duct pressure should be max. 250Pa.

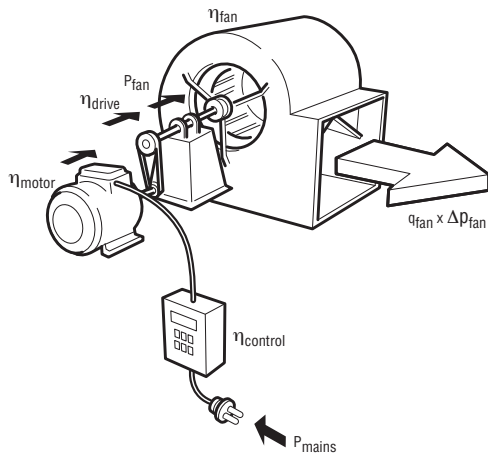

### Calculation of fan power, $P_{mains}$

$$P_{mains} = \frac{q_{fan} \cdot \Delta p_{fan}}{\eta_{fan} \cdot \eta_{drive} \cdot \eta_{motor} \cdot \eta_{control} \cdot 1000}$$

$\eta$  = efficiencies for fan, drive, motor and control equipment (see fig).

For a unit with rotary heat exchanger the calculation of the mains power demand for the extract air fan motor shall include the power used for leakage and heat-exchanger purging air flows. Any throttling on the extract air side necessary for achieving the correct pressure balance and direction of air leakage in the unit shall also be included.

## Power efficient fans

In order to obtain low VAS-class e.g. low specific fan power SFP in an air distribution system, one must first make certain that the pressure drop in unit and air distribution system are kept low, since the use of electric power is directly proportional to the pressure rise of the fan.

It is of course important that the efficiencies of the fan, motor, possible drives and controls are as high as possible, since the use of electric power is conversely proportional to these efficiencies.

## Controls

The simplest and least expensive way to control the air flow through a fan is to change the resistance, e.g. use a damper to throttle the air flow, although this method is disadvantageous from an energy point of view. Another method is to control the flow by means of adjustable guide vanes in the fan inlet, which reduces the air flow with fewer losses than in the case of damper control.

The most energy-efficient way to control a fan is by

continuously adapting the fan speed to meet the need, by means of a frequency inverter. By controlling the speed exactly according to the need, the power demand can decrease by 50% compared to throttling flow control. The figure shows how the power demand is dependent on the volume flow in various control methods.

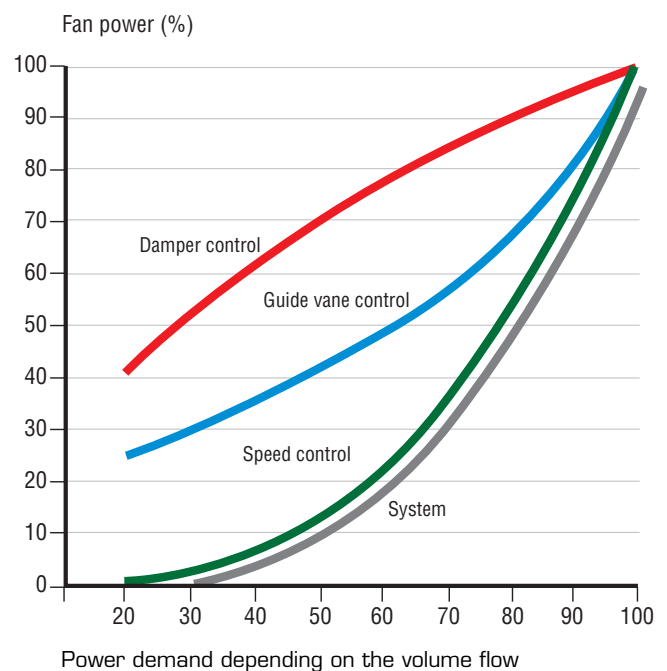



## Summary



A fan consists among other things of an impeller, which in turn consists of a number of blades, which are fastened to a hub. As the impeller rotates, the blades work with the air so that the air pressure increases. The pressure difference between the fan and e.g. the room at the end of the duct makes the air move. Normally the impeller is driven by an electric motor.

The fan generates a total air pressure rise, which consists of static and dynamic part.

Since we would like the air to move rather slow in the duct in order to minimize both pressure losses and the sound, we are not interested in generating a high dynamic pressure in the fan. For this reason, fans are designed so that all dynamic pressure is transformed to static pressure within or by the fan outlet.

Fans for comfort ventilation can be divided into two groups: Centrifugal fans and Axial-flow fans.

In the centrifugal fan the air enters the fan in a direction parallel to the shaft of the impeller, but leaves it in a direction which is perpendicular to the shaft. The plenum fan is a centrifugal fan without spiral-shaped fan casing.

For a given impeller diameter and speed, the fan with forward-curved blades however generates the highest pressure and therefore enables the most compact design for a given pressure. In relation to the size of the fan it also supplies a substantial flow. The main disadvantage of the fan with forward-curved blades is its relatively low efficiency and limited top speed. The fan with forward-curved blades is commonly used in small ventilation systems.

Centrifugal fans with backward-curved impeller consist of several blades, which form centrifugal diffusers. Static pressure is generated when the air flows through the impeller and the fan casing is not as important as it is for the forward-curved impeller type, yet it has the same diffusing function and gives the fan high efficiency. An impeller with backward-

curved blades must be operated twice the speed of an impeller with forward curved impeller of same diameter in order to obtain the same pressure and flow. The backward-curved blades also provide high efficiency and the robust design allows higher max speeds than the centrifugal fan with forward-curved blades.

The plenum fan has an impeller with backward-curved blades but has no fan casing. Its performance is similar to that of the centrifugal fan with backward-curved blades, but with no advantage of the static pressure recovery in the fan casing. The advantage of using plenum fans is that they are direct-driven and lack drive belts, which otherwise would require maintenance.

Axial-flow fans produce relatively large air-flows at low pressures. The larger fan diameter and rotation speed the higher the pressure will become. The axial flow-fan is most suitable for large air handling units.

The performance of the fan is normally shown in the form of a chart with airflow drawn on the longitudinal axis and the pressure on the vertical axis.

The efficiency of the fan is defined as the ratio of the flow multiplied by the total pressure and the shaft power on the impeller shaft.

When selecting a motor, the load torque for the motor must be less than minimum torque. A measure of how well a motor converts electric energy to useful work is the motor efficiency. A motor can be started directly on-line or by a star / delta starter. Electrically commutated motors (EC motors) are an innovation offering higher efficiency. To obtain a measure of how efficiently the electric power supplied to an air treatment system is utilized, we can calculate the SFP-value (Specific Fan Power) of the air handling unit.



# Air Heaters and Air Coolers



The chapter deals with the following

- Air heaters and Air coolers, Coils
- Cooling units
- Indirect evaporative cooling, Coolmaster®
- Electric air heaters

Coils are used for heating and cooling air in an air treatment system. Since every product is adapted to a special function, two coils are seldom alike, but the basic principal is always the same.

The coils are composed of a large number of thin plates, fins, with holes for tubes. Tubes are fitted into holes of the fins and are mechanically expanded to fit snugly in the fins.

This design makes it possible for the water flowing through the tubes to effectively heat or cool the air passing through the coil. The fins are usually made of aluminium and the tubes are made of copper, but they are available in several other materials.

Coils are mainly intended for heating or cooling of air and other gases.

Among others, warm or hot water evaporative refrigerant, oil, process fluid or steam is used as the heating medium.

Chilled water, evaporative refrigerant, oil or other liquid is used as the cooling medium.

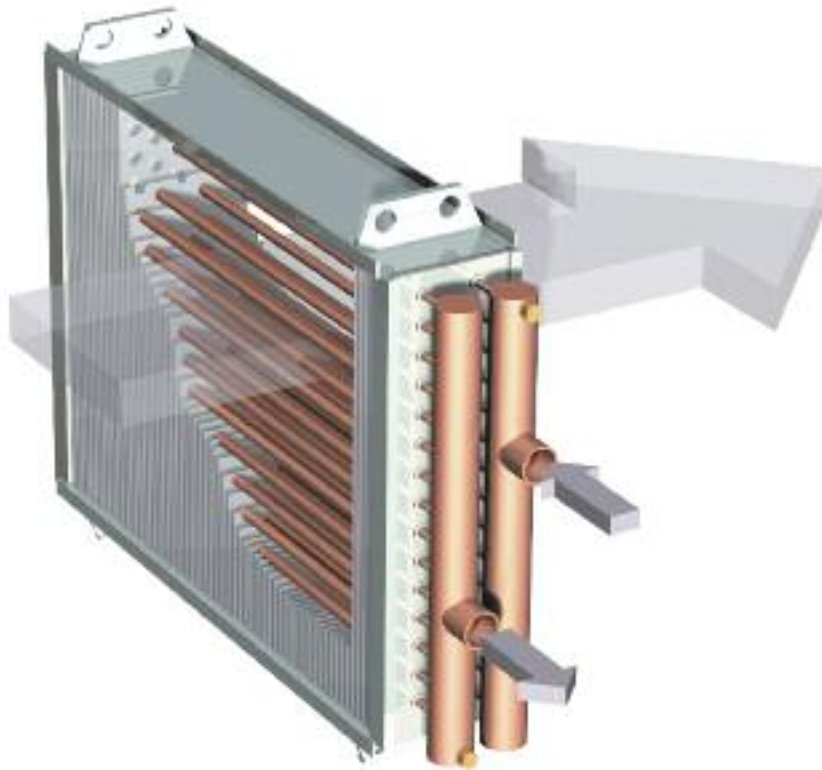

## Design

A coil is built-up of a number of tubes arranged in one or several rows, in the direction of the air flow. The tubes may be staggered to increase the effectiveness, which is normal in Fläkt Woods AHUs. The tubes are connected to loops of a length suited to the water temperatures. The heat or cooling energy conveying medium flows through the tube loops and the air flows on the outside.

The tubes are fitted with fins to provide a sufficiently large heat transfer area to, compensate for the low heat transfer coefficient on the air side. The fins are fixed on the tubes, by means of expansion of each tube. This achieves excellent heat transfer to the fins. The copper tubes are completely protected by the fins. The tubes are brazed to headers, which have male-threaded connections.

The headers on Fläkt Woods AHU coils have plugged connections for venting and drainage. The drain connection can be fitted with a sensor for an anti-frost protection thermostat.

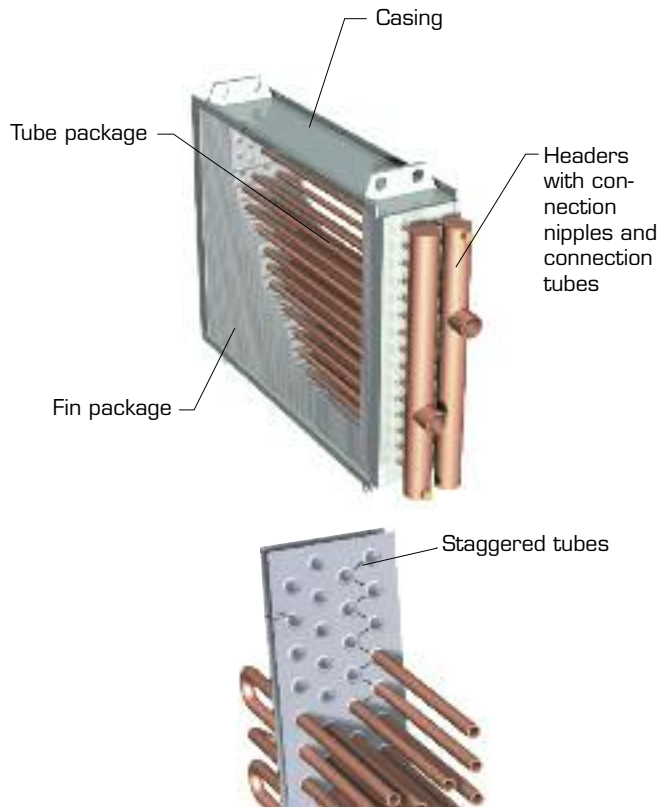

## Various modes of connection

The tubes/coils can be connected, so that the heat or cooling energy conveying medium flows in different ways in relation to the air flow. See the fig. below.

### CROSS-FLOW CONNECTION

is used for condensing steam, and on air heaters with low capacity output.

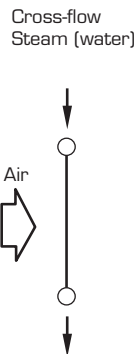

### PARALLEL-FLOW CONNECTION

is sometimes used on air heaters where provision for a sensor for an anti-frost protection thermostat is prioritized. If a heat exchanger connected in this mode is incorrectly installed, the reduction in capacity may be as much as 1 %.

In applications, in which the air or heat/cooling energy conveying medium flow is crucial for coil performance; the direction is marked on the coil.

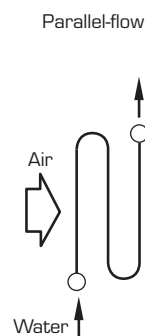

### COUNTER-FLOW CONNECTION

is most common and is used for cooling coils, air heaters and heat recovery with high capacity. This connection offers the highest capacity.

Left-hand version

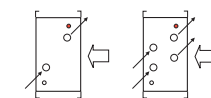

Right-hand version

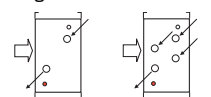

Counter-flow

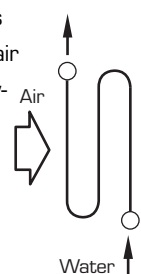

## Coil circuits

Increasing the number of tube rows and the depth of the heat exchanger will increase its capacity. The disadvantage is that the pressure drop on the air side increases, thus causing the fan to consume more energy in order to maintain the airflow. In an attempt to increase the capacity of the heat exchanger, the first thing to change should be to increase the number of water paths.

The number of tube rows on the heat exchanger should be increased only if the max. permissible pressure drop on the water side is exceeded, or if the capacity is insufficient.

The number of tube rows or the tube depth denotes the number of tubes in the direction of air flow and determines the physical depth of the fin package.

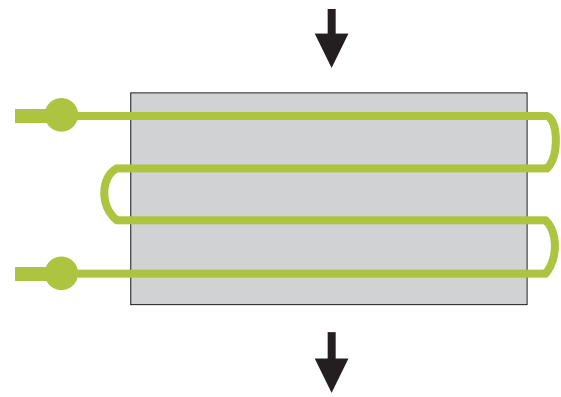
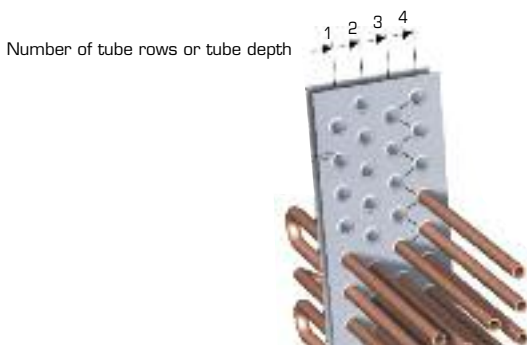

4 water passes, 1 circuit.

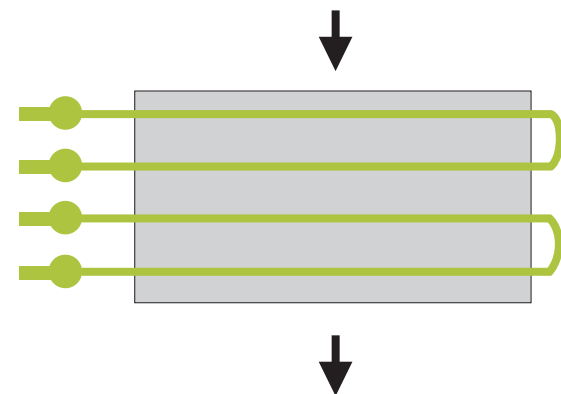

2 water passes, 2 circuits.

The pressure drop of the water and the difference in water temperature increases on an increasing number of water paths.

The coil can be made with one or more circuits. The longer the circuit the greater the water pressure drop will be. It is important to check that the circuitry is optimised to the required water temperatures before increasing the number of tube rows to obtain greater capacity.

## Coils for evaporative refrigerant

Coils used for evaporative refrigerant can be divided up into two or more output stages (depending on the height of the coil).

Two output stages are normally connected, so that every other loop belongs to output stage 1 and the intervening loops belong to output stage 2 (interlace-connection)

### Break-down into output stages, marking

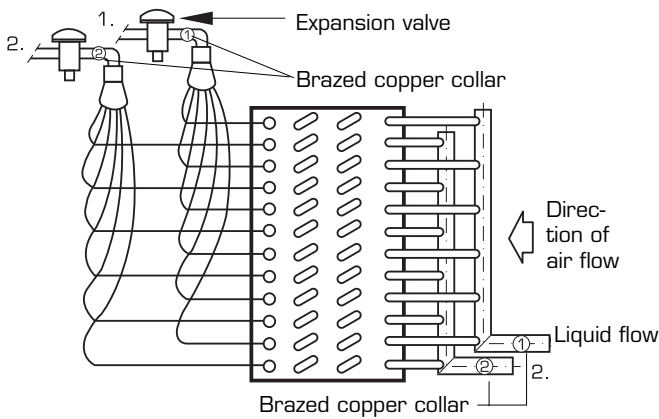

Three or more output stages are normally split up vertically

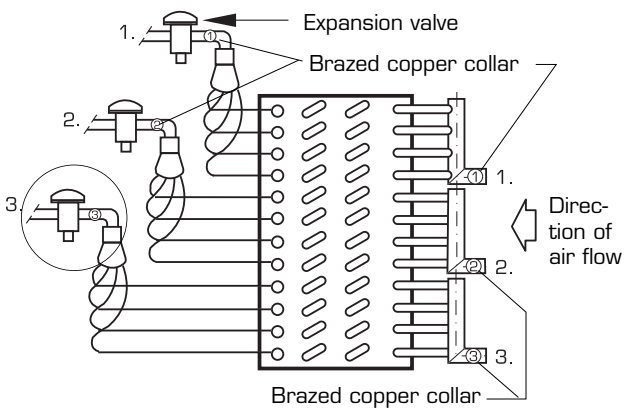

## Normal fluid velocities for coils

	Cooling coil, m/s	Air heater, m/s
Air velocity	2 – 3 <sup>1)</sup>	2 – 5
Liquid velocity	0,2 <sup>2)</sup> – 2 <sup>3)</sup>	0,2 <sup>2)</sup> – 1,5 <sup>3)</sup>

- 1) For velocities in excess of 3 m/s, a droplet separator should be fitted.
- 2) Min. velocity depending on the temperature of the liquid
- 3) Max. velocity for copper tubes conditional on risk of erosion. The water velocity in steel tube coils should not exceed 3 m/s.

Cooling coils are fitted with distributors on the inlet side as shown above. The expansion valves are normally not fitted. Manifold pipes are fitted on the discharge condensings coils are fitted with manifold pipes on both sides of the coil.

# Cooling units

The cooling unit is a ready-to-use, complete unit with all the necessary components including the controls. The product name/brand for Fläkt Woods cooling unit is Cooler.

The cooling principal used is direct expansion with capacity control in three steps.

The condenser is located in the extract air and the evaporator is located in the supply air.

## The evaporator

The refrigerant boils inside the evaporator and is transformed from liquid to gas. For this to take place, heat is absorbed from the supply air, cooling it.

The evaporator is a coil composed of copper tubes and aluminium fins.

The evaporator is equipped with a drain tray made of stainless steel sheet.

## The compressor

The gas enters the compressor and is compressed to a higher pressure. This also raises the temperature.

## The condenser

The refrigerant is condensed in the condenser and is transformed from gas to liquid. For this to take place, heat must be emitted to the extract air. The condenser is a coil composed of copper tubes and aluminium fins.

## Expansion valve

The expansion valve operates like a throttle valve, which regulates the amount of refrigerant circulating in the refrigerant circuit. It does this by optimizing the temperature downstream of the evaporator. This also prevents liquid from entering the compressor. The compressor is a gas pump that breaks down, if it tries to compress liquid. It is important to the function of the expansion valve that the refrigerant is a pure liquid without any gas intermixture before it is throttled.





## High pressure switch

There are pressure switches mounted on the outlet side of the compressor which stop the compressor when the pressure becomes too high. These switches are there to safeguard the system and to prevent the compressors from increasing the pressure too much. They should not trip during normal operation. The high pressure switches are equipped with manual reset buttons.

## High pressure switch (in-operation)

The first compressor in the system is also equipped with a second high pressure switch, which resets itself automatically and which is preset to trip at a lower pressure than the high pressure switches mentioned above.

This pressure switch trips when both compressors are in operation and the load on the condenser becomes too high. The pressure switch then switches off the first compressor, which causes the cooling unit to switch from the third cooling stage to the second one. This reduces the load on the condenser and allows the cooling unit to continue to operate, though at a lower cooling capacity. This occurs when the design operating conditions have been exceeded. Since the pressure switch resets itself automatically, the third stage will start up again when the pressure is low enough.

## Low pressure switch

There are low pressure switches mounted on the suction side of the compressors. These switches stop the compressors when the pressure becomes too low, which can occur when the air temperatures are low. The low pressure switches also trip if a refrigerant leakage should occur.

## Liquid filter

A liquid filter is mounted just upstream of the expansion valve. Its function is to remove particles and to clean the circuit from water vapour.

## Sight glass

There is a sight glass with integrated moisture indicator mounted downstream of the filters. The moisture-sensitive bulb changes colour on a change in moisture content.

The sight glass can also indicate if any refrigerant leakage has occurred.

## Passive refrigerant collection container

A liquid receiver is mounted on certain coolers. This is a refrigerant container, which can be used for storing the cooling medium if the components in the refrigerant circuit need to be replaced. Since the receiver does not have any role to play in the normal operation of the machine, it is isolated by the shut-off valves from the rest of the system.

## Water cooled condenser

The water cooled condenser functions as a complement to the air cooled condenser. It can be selected as an accessory if the air cooled condenser cannot remove enough heat. This may be because the extract air temperature is a bit too high, or because the flow velocity is lower than the velocity on the supply air side.

The water cooled condenser may also be used to recover heat for the hot water system of the building.

## Selection of cooling unit

The selection of cooling unit depends first and foremost on the size of the air handling unit. After that, the output variant corresponding to the cooling demand and should be selected.

# Indirect Evaporative Cooling

An innovative way to cool the premises is by using indirect evaporative cooling. Fläkt Wood's product for indirect evaporative cooling is called COOLMASTER®. Indirect Evaporative Cooling (IEC) involves cooling the extract air or outdoor air by means of an evaporative humidifier (read more about this in the chapter about humidifiers) and transferring the cooling power to the supply air via an effective heat exchanger that does not transfer moisture it is particularly suited to drier climates.

Indirect Evaporative Cooling can in many cases be used for creating a refreshing indoor temperature in the summer time. Its cooling power can reduce the room temperature by as much as 7 – 8 °C, which is of great importance for comfort and performance.

Water absorbs heat from the surroundings as it evaporates. The evaporator thus cools down the air when it supplies moisture.

The main parts in a COOLMASTER® cooling system are the humidifier, which cools the extract air and an efficient heat exchanger, which transfers the cooling power to the supply air.

When the outdoor temperature is high, the air evaporator cools the extract air from the room.

The extract air then cools the outdoor air via the heat exchanger, before the air is conveyed to the room.

If the system is to have maximal output, it is important that air humidifier as well as heat exchanger operate at best possible efficiency. It is also desirable that the pressure drop across the system (especially on the supply air side) is low, and that fan and motor with the highest possible efficiency are used to give a low temperature rise across fan and ducts on the supply air side.

COOLMASTER® may be supplemented with a humidifier on the supply air side for generating additional cooling performance. In some cases the outdoor air is so dry that a certain amount of humidification can be tolerated, without the humidity in the room becoming too high. A plate heat exchanger or a run-around coil energy recovery system can be used instead of the rotary heat exchanger. The cooling capacity will then be reduced by approx. 15-20%.

COOLMASTER® with the ECONET® may provide the same performance as a unit with rotary heat exchanger. COOLMASTER® offers the best performance:

- for small internal loads (temperature and moisture)
- with displacement air distribution (low-momentum air devices)
- in places with relative dry climate.

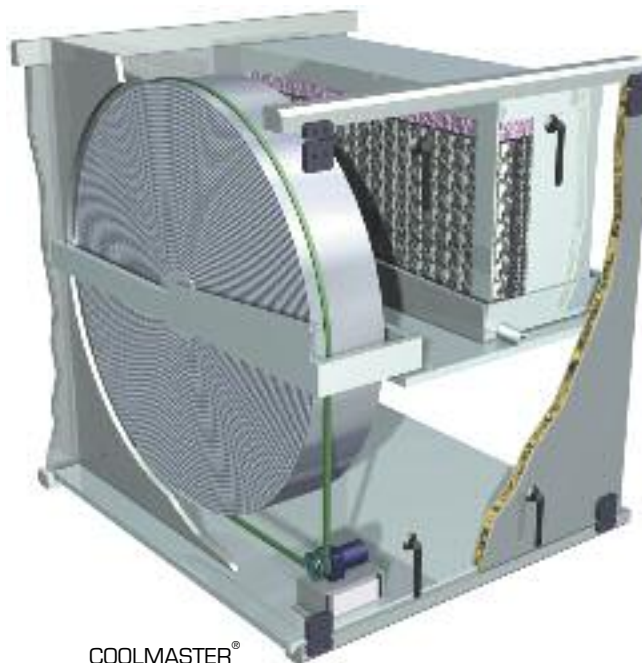

COOLMASTER®

## Extract air humidification or outdoor air humidification

The installation cost will be the lowest if the extract air is utilized for evaporative cooling.

– An installation example is shown in the figure below.

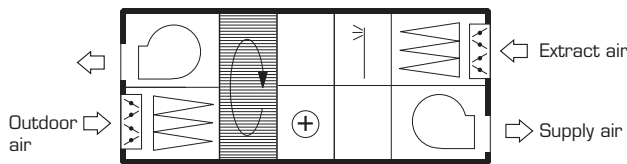

Extract air humidification

If the internal loads are substantial, the extract air will be warmer than the outdoor air. The output will then be greater by cooling outdoor air instead of extract air. The installation cost becomes higher than for cooling the extract air, since the fan and damper etc. are added. An installation example is shown in the figure below.

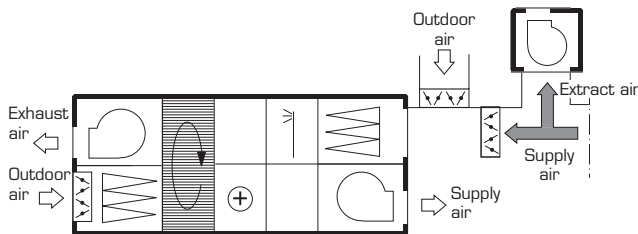

Outdoor air humidification

Extract air humidification is preferable if the internal load  $\Delta t_{\text{internal}}$  är 6°C or lower.

( $\Delta t_{\text{internal}} = t_{\text{extract air}} - t_{\text{supply air}}$ ).

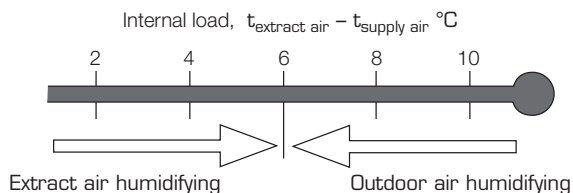

This is how it is in most offices and industrial premises. The outdoor air humidification is preferable if the internal loads are 6 °C or higher.

## Calculation of cooling power

The cooling performance of the COOLMASTER® system is conditional on the absolute humidity of the outdoor air. The drier the air, the easier it is to cool it, and the more cooling power that the system can deliver.

The cooling power is also conditional on the internal load (temperature and moisture), if extract air is utilized.

## Night-time cooling

COOLMASTER® can also be operated at night in order to provide a maximal cooling performance. This function utilizes the heat-storing capability of the building by chilling the building structure, etc. This in turn helps to keep the temperature low during the day. In this way the comfort can be very good even during a long-term heat wave.

## Total energy

The operating cost depends on the climate at the location and on how the system is utilized, and of course on the energy and water costs at the location.

The pressure drop across the humidifier involves a higher energy cost to operate the extract air fan. But that is much less than running a convention cooling machine. The increase can however be halved if the humidifier cassette is removed during the winter section.

## Safe

Wherever there is moisture, there is risk for bacteria growth. This risk is present for cooling coils as well as for air humidifiers.

To avoid pollution of the supply air, it is important to prevent the formation of aerosols, which can spread bacteria and to carry out maintenance correctly. Good filters in the extract air as well as the supply air ducts are also important for good ventilation hygiene.

The evaporation in the evaporator does not create any aerosols and the humidifier in the COOLMASTER® is also mounted in the extract airflow. This involves in a minimum of moisture in the supply air section of the air handling unit.

# Electric air heaters

An electric air heater consists of a number of heating elements, which are located in the airflow in the air handling unit.

When electric current passes through the elements, they become hot and give off heat to the air. Each individual element gives off a constant heat output.

The air temperature can be regulated by switching on a sufficient number of elements. A stepping switch unit connected to relays provides this function. Of course this means that the air temperature tends to change in steps, which may not be desirable.

A thyristor controller can be utilized to vary the output.

Air handling units with electric air heater can be installed in dry premises where there is no risk of fire or explosion and garages where petrol is not normally handled.

The air velocity across the front velocity of the air heater must not be lower than 1.5 m/s. The max. air temperature downstream of the air heater must not exceed 40 °C.

Electric heaters provide a low overall installation cost where there is no convenient supply of hot water. The running costs will generally be high however.



## Summary

### Coils air heater and air cooler

Coils are used for heating and cooling air in air handling systems, for example.

The coils are composed of a large number of thin plates, fins, with holes for tubes. Tubes are fitted into holes of the fins and are mechanically expanded to fit snugly in the fins.

This design makes it possible for the water flowing through the tubes to effectively heat or cool the air passing through the coil.

The tubes/coils can be connected, so that the heat or cooling energy carrier flows in different ways in relation to the air flow: cross-flow connection, counter-flow connection and parallel-flow connection.

Counter-flow connection is most common and is used in cooling coils, air heaters and heat recovery with high capacity. This mode of connection offers the highest capacity.

### The cooling unit

The cooling unit is a ready-to-use, complete unit with all the necessary components including the controls. The cooling principal is direct

expansion with capacity control in three steps.

A cooling unit consists of an evaporator, compressor, condenser, expansion valve, high pressure switch (in-operation), low pressure switch, liquid filter, sight glass, passive refrigerant collection container and water-cooled condenser.

### Indirect Evaporative Cooling (IEC)

An innovative way to cool the premises is by using indirect evaporative cooling (IEC). This involves cooling the extract air or outdoor air by means of an evaporative humidifier and transferring the cooling power to the supply air via an effective heat exchanger that does not transfer moisture.

### Electric air heater

An electric air heater consists of a number of heating elements, which are located in the airflow in the air handling unit.

When electric current passes through the elements, they become hot and give off heat to the air offer low installation cost.

# 15

## Heat exchangers

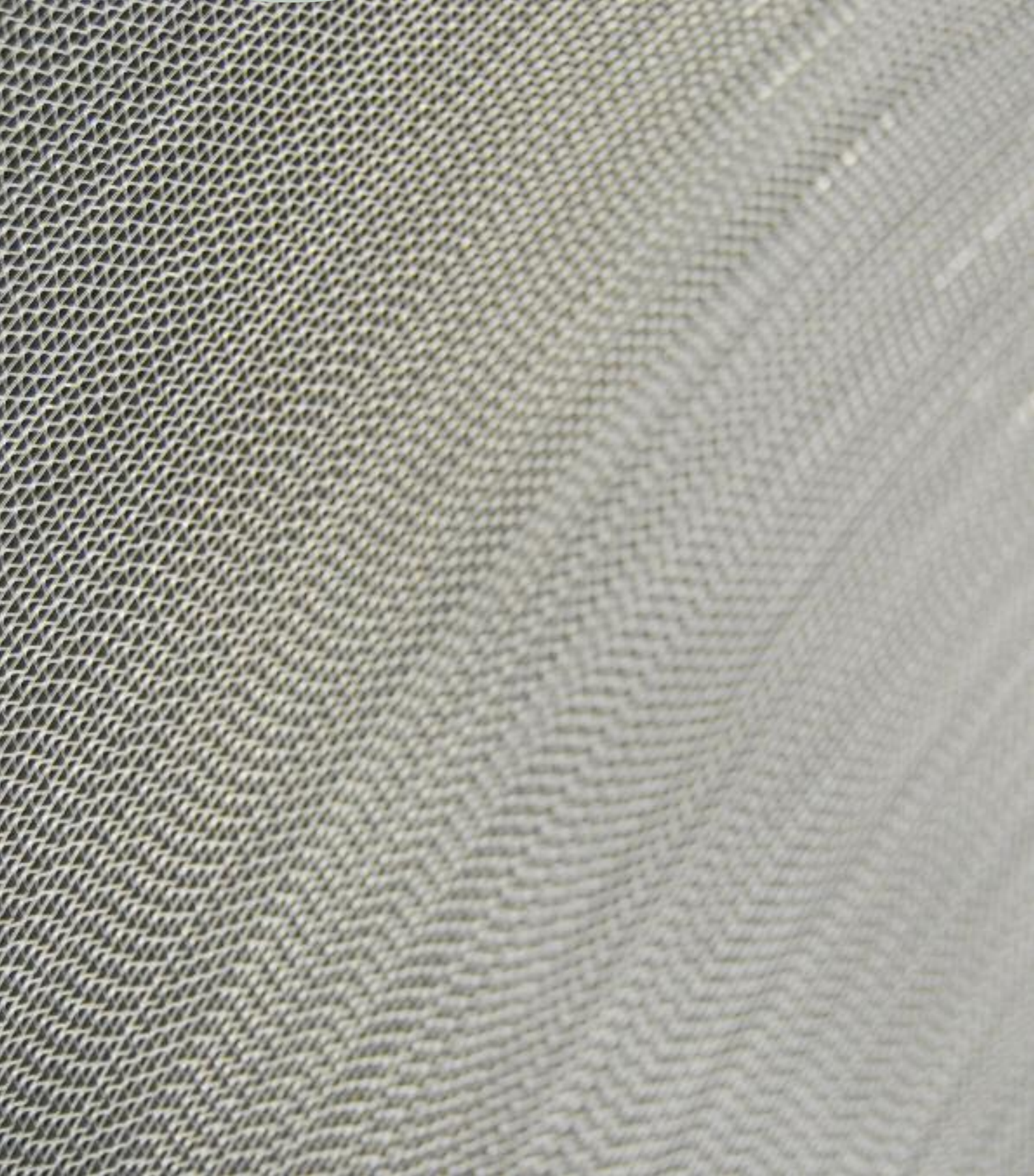

The chapter deals with the following



- Rotary heat exchangers
  - Purging sector
  - Frosting and defrosting
  - Corrosion protection
  - Hygroscopic, None-hygroscopic
- Plate heat exchangers
  - Defrosting
  - Leakage
- Liquid-coupled systems
  - Efficiency
  - Control and anti-frost protection
  - The ECONET®-system



Rotary heat exchanger



Plate heat exchanger



Liquid-coupled heat exchanger

A variety of systems used for the recovery of heat and cooling energy in comfort ventilation are available, most common are:

- Rotary heat exchanger
- Plate heat exchanger
- Liquid-coupled systems

There are a number of factors to be considered when selecting a system. Some of the most important are:

- Efficiency and pressure drop (energy)
- Space
- Provision for duct connection
- Leakage, odour transfer
- Activity conducted in the building
- Need for latent cooling
- Kind of energy source

It is important to select a system based on the pre-requisites that prevail in the particular application.

## Rotary heat exchangers

The rotary heat exchanger consists of a rotor, casing and drive system. The rotor is normally composed of a matrix of thin aluminium foil triangular ducts. The surface can be made to be hygroscopic and can therefore also transfer moisture. The ducts are small enough for the flow to become laminar or semi-turbulent. The Fläkt Woods' product names for rotary heat exchangers are REGOTERM® and TURBOTERM®.

The rotor operates in pure counter flow and without intermediate medium and has therefore a very high efficiency (for a given pressure drop), compared to other recovery systems.

The temperature efficiency is regulated by changing the rotor speed, or via by-pass damper.

The drive apparatus has a motor for variable or constant speed, transmission and drive belt. The drive system controls the rotor speed from a top speed of approx. 20 revolutions per minute down to approx. 0.5 revolutions per minute offering fully modulating control 100% of capacity.

If need for defrosting of the rotor arises, this is most easily done by reducing the rotor speed via drive equipment with variable speed. If the rotor becomes

substantially frosted, a drip tray with drainage may be required, but only in extreme conditions.

Constant speed may be used in the tropics for the recovery of cooling energy since the demand is constant.

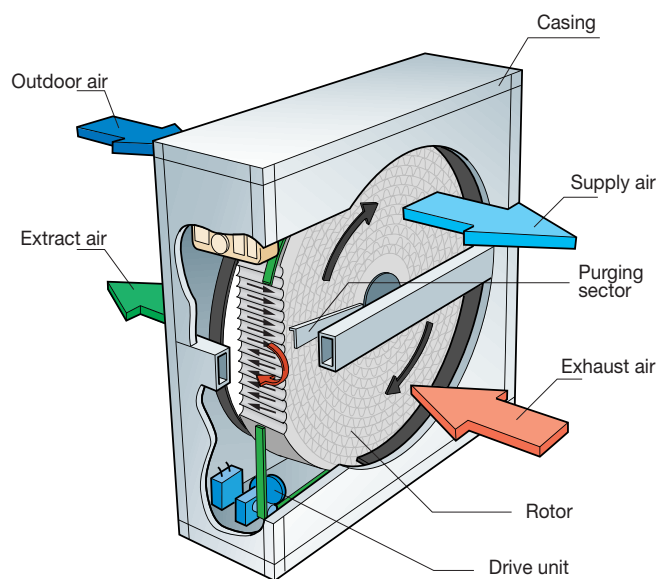

Rotary heat exchanger, operating principle

## Purging sector

A purging sector is used for preventing extract air from being carried over by rotation to the supply air side. In the sector there is direct connection between clean air and extract air/exhaust air. The pressure difference between supply and extract is used to purge the passages of extract air preventing carry-over. An example of how a sector operates is illustrated below.

The purging flow can under correct pressure conditions be negligibly small. If the sector is too small to manage purging at the current speed and pressure difference,  $p_{21} - p_{11}$ , extract air will leak to supply air and there will be risk for odour transfer. If the sector is too large, a certain amount of clean air will leak over to the

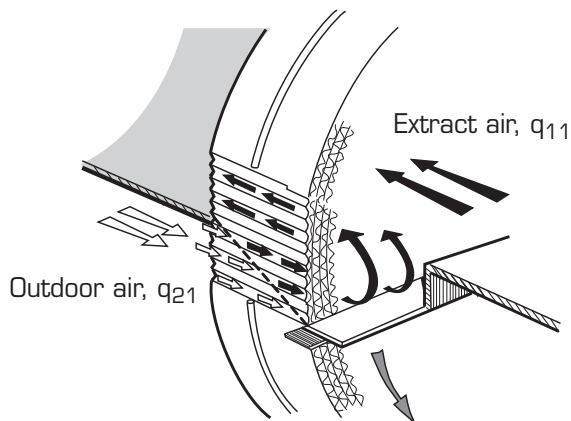

Example on how a sector functions

extract air side. Even if the purging sector is large enough, gases with strong odours and particles in the extract air (e.g. cigarette smoke and cooking odours) can be transferred to the supply air by adsorption on the rotor surfaces.

The 3Å surface treatment of the Fläkt Woods-Semco rotary heat exchanger avoids this problem.

The design with rotor causes leakage flows  $q_{21}$ , carry-over flow  $q_{mv}$ , by-pass flows  $q_{by-pass}$  and possibly also purging flow  $q_{purging}$ . The leakage flow is minimized and is given the correct direction by a proper pressure balance around the rotor. This may be achieved with the correct fan location and effective sealing. Possibly, a trim damper will be required in the extract air duct.

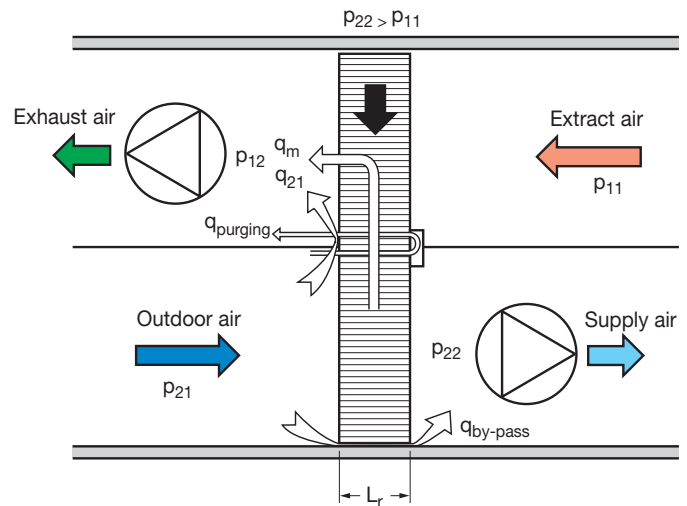

Leakage flows and transfer



## Frosting

When the outdoor temperatures are low, condensation will be precipitated on the extract air side, which later normally evaporates on the supply air side. If the moisture content in the extract air is high and the outdoor temperature is very low, the rate of condensation will be greater than that of evaporation and surplus water will accumulate in the rotor.

If the mean temperature during the revolution is lower than 0 °C, the water will freeze to frost and a system for defrosting will be required.

For normal comfort ventilation without air humidification, a hygroscopic rotor can operate down to approx. -25 °C without surplus water and defrosting. A non-hygroscopic rotor can operate down to approx. -15 °C. A check can be made by using the Mollier chart. If the straight line between the extract air and outdoor condition does not intersect the saturation line, no surplus water will arise.

## Defrosting

Defrosting can take place by regulating the speed down to approx. 0.5 revolutions/minute. It starts by means of a pressure switch at a value that is approx. 50 Pa higher than the pressure after defrosting, which in turn is approx. 30% higher than the normal pressure drop due to the water in the rotor.

As an alternative, the defrosting mode can be controlled by means of a timer, which is activated when the temperature is below -15 °C and provides defrosting 2 - 3 times every 24-hour period. A frosting process can take many hours. Defrosting can take 15 - 20 minutes.

During this time the temperature efficiency will be low (20 - 30%) and you should supply heat in the air heater.

An alternative to defrosting is to preheat the outdoor air to a temperature at which frosting will not occur. If the heat exchanger has a hygroscopic rotor, the Psychrometric chart can be used for determining the limit temperature.

## Corrosion protection

In certain environments the rotor may need corrosion protection. The rotor is then equipped with edge reinforcement.

In highly corrosive environments, epoxy-coated aluminium can be used.

## Application

Due to its high efficiency the rotary heat exchanger is the first choice when:

- The extract air is clean enough
- Supply air and extract air ducts converge at the same location
- Moisture recovery can be utilized
- A certain recirculation of gases and particles from the extract air can be tolerated.

## Hygroscopic and non-hygroscopic rotor

Rotary heat exchangers can be subdivided into two groups: non-hygroscopic and hygroscopic.

If we disregard moisture transfer which can occur under certain temperature conditions, the non-hygroscopic rotor transfers sensible heat only.

On the other hand, the hygroscopic rotors transfer both sensible and latent heat under all circumstances. While the efficiency of the non-hygroscopic rotors on the whole is determined by the size of the heat transfer surface and the speed, the efficiency of hygroscopic rotors is more complicated.

In that respect, the properties of the hygroscopic surface layer enter in as an important parameter. There are hygroscopic rotors that offer completely different performance in this respect.

### Non-hygroscopic

The non-hygroscopic rotors are composed of thin untreated sheets of aluminium, in certain cases epoxy-coated to protect surfaces from corroding. These rotors transfer sensible heat only except in applications in which condensation precipitation contributes to a certain moisture transfer.

If the outdoor air is sufficiently cold and the extract air is warm and humid, moisture will condense on the extract air side and will evaporate on the supply air side, and in this way will transfer a certain amount of moisture to the air.

If the outdoor air is very cold, frost will form inside the rotor and defrosting will be necessary to remove it. Whether frost forms on surfaces and how quickly this takes place depends mainly on the temperature of the outdoor air and the moisture content of the extract air.

In comfort ventilation applications without any supply of humidified air to the rooms, the rotor can manage outdoor temperatures as low as approx. -15 °C without any frost problem.

The non-hygroscopic rotors are used mainly for heat recovery during the winter. Cooling energy recovery during the summer will be very limited since the rotor transfers sensible heat only.

### Hygroscopic

The hygroscopic rotors that are composed of thin sheets of aluminium have undergone a treatment that has made the surface hygroscopic i.e. the surface has a high capacity for absorbing and emitting water molecules. Rotors made of micro glass which has been made hygroscopic by means of various types of coatings are also available.

When a rotor passage is on the side that has the highest vapour pressure for water vapour, the water molecules will be adsorbed on the surface and will be later emitted to the air on the dry side.

This provides moisture transfer and the transfer of latent heat which are analogue with the heat transfer of sensible heat. A hygroscopic rotor can cope with the frost problem better than a non-hygroscopic rotor.

When normal comfort ventilation is used, the rotor can operate if the outdoor temperature drops down to approx. -25 °C without any frosting problem.

On the other hand, if the relative humidity in the extract air is 50%, due to circumstances that cause humidity in the rooms, the limit temperature will be approx. -8 °C.

Frosting on surfaces in a comfort ventilation application is a process that takes place over a number of hours and if the ventilation system is utilized for example during the day only, it can be defrosted during non-operating hours. In that the hygroscopic rotor transfers moisture, it contributes to a better indoor climate during the winter when the air indoors otherwise tends to be too dry. In the summer when the outdoor is warm and humid, the rotor dries the air and generates a drier and cooler indoor climate. In a warm climate the hygroscopic rotor offers a substantial savings of cooling energy.

The example shows a comparison of moisture transfer under winter conditions for a non-hygroscopic rotor (left) and a hygroscopic rotor (right). Based on this comparison, we see that the moisture content is higher in the hygroscopic rotor.

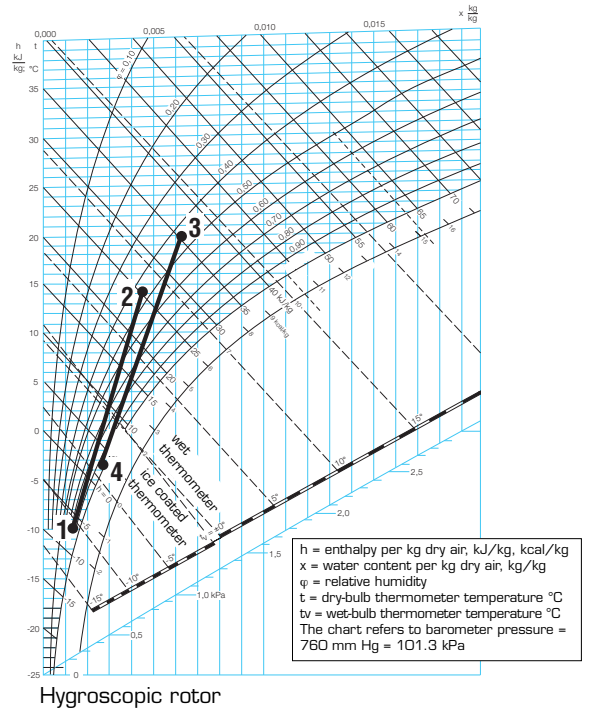
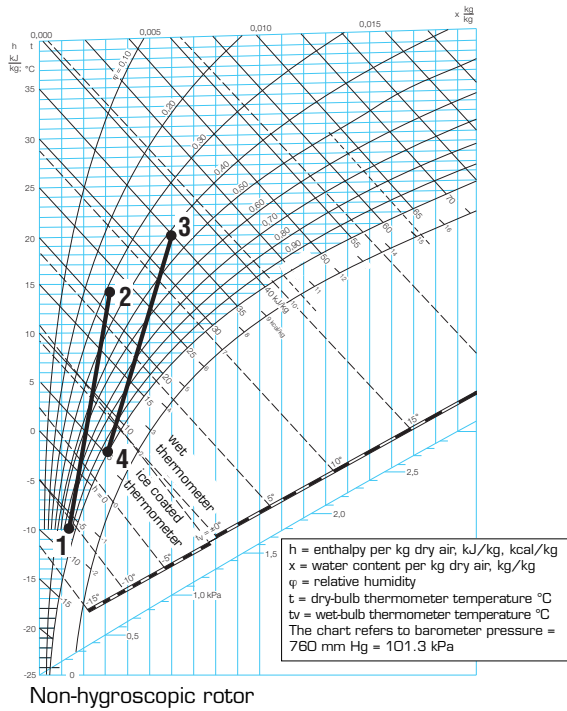

The example shows a comparison of moisture transfer under summer conditions for a non-hygroscopic rotor (left) and a hygroscopic rotor (right). We see here that the hygroscopic rotor transfers more energy (line 3 – 4) than the non-hygroscopic rotor. This is because it also transfers latent energy.

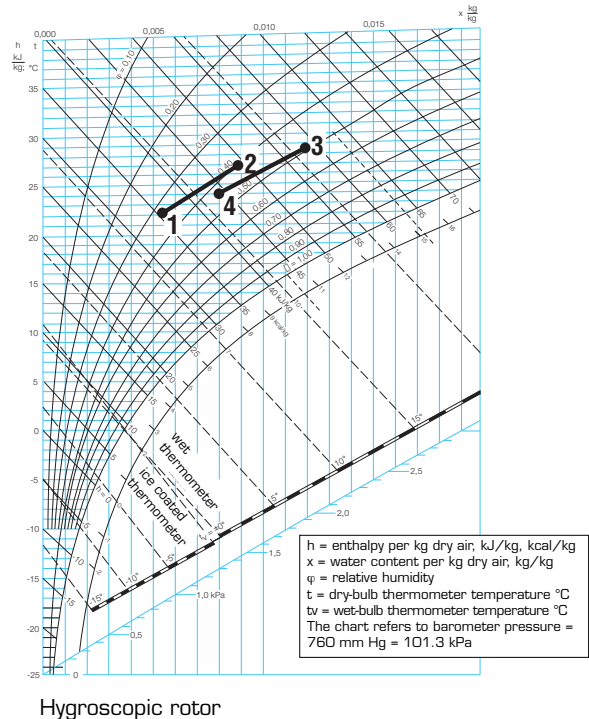
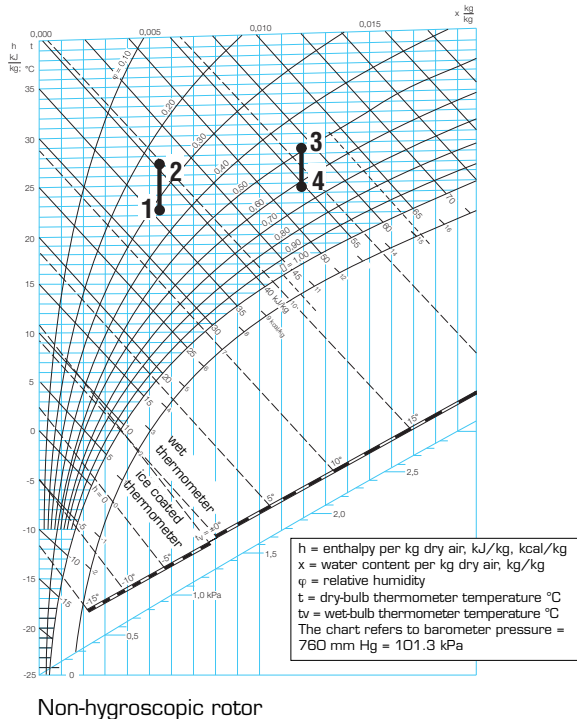

## System with double rotors

A system with double rotors is composed of a hygroscopic rotor, a cooling coil and a sensible rotor. The Fläkt Woods system for this is called Twin Wheel. The system is used for cooling and drying of the air. This is important in certain applications such as chilled beam systems in which low moisture content is desirable in order to prevent condensation. In traditional air handling units this is often carried out by first cooling the air in a cooling coil, to condense out unwanted moisture content, and then passing it through an air heater, where the temperature increases to the level required. The disadvantage with this system is that the operating costs for the heating coil and the cooling coil are high.

When cooling is required and the outdoor air is warmer than the extract air, the hygroscopic rotor operates to decrease the temperature of the incoming outdoor air and at the same time transfer a certain amount of moisture from the outdoor air to the exhaust air, if the absolute humidity in the outdoor air is also higher than that in the extract air.

After the outdoor air has passed the hygroscopic rotor, it flows further on through the cooling coil,

where its temperature decreases further and moisture condenses to provide the required moisture level in the air. The now dehumidified and cooled air then continues through the sensible rotor, where the higher temperature in the extract air heats the air to the required temperature, to be later conveyed as supply air to the building.

The end result will be conditioned temperature with controlled moisture. This makes the system especially well suited for premises with chilled beams, where a lowest possible moisture content in the supply air is desirable.

The exchange of temperature in the sensible rotor therefore decreases the temperature in the extract air and this improves cooling recovery performance in the hygroscopic rotor.

In that the supply air temperature decreases before it reaches the cooling coil, the capacity load on the cooling coil also decreases.

The system also requires less cooling coil capacity because the temperature of the supply air has dropped before it reaches the cooling coil. This reduces the need for cooling power by half. At the same time, there is in most applications no longer any need for an air heater.

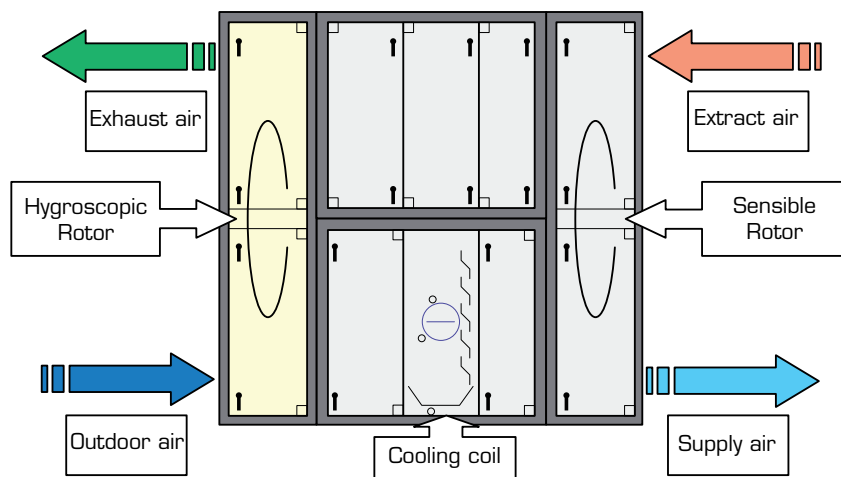

## Plate heat exchangers

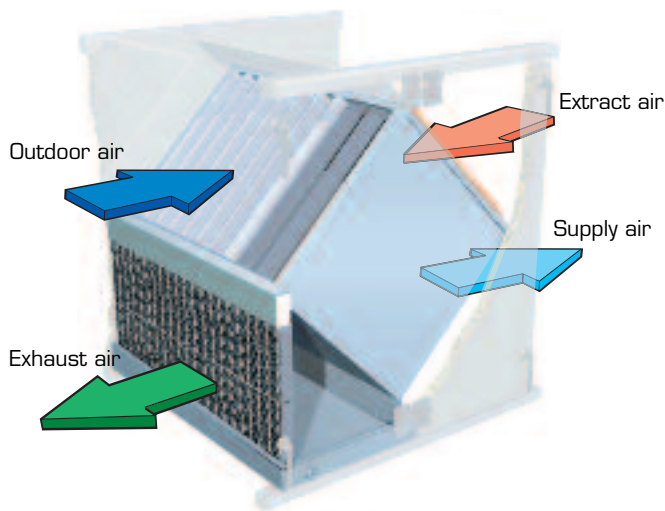

### Design

Plate heat exchangers consist of a number of square, parallel plates. Warm air and cold air flow in every other air passage between the plates and the heat is transferred through the plates. Fläkt Woods' product name for plate heat exchangers is RECUTERM®.

The plates are thin and are made of a heat conducting material so that the air-to-air heat transmission coefficient will be substantial. The heat exchanger has to be constructed in a cross-flow configuration to make it possible to have air connections. This makes the temperature efficiency considerably lower than that of the rotary heat exchanger. This also means that the corner between outdoor air side and exhaust air side is a so-called "cold corner" with low supply air temperature.

If the outdoor air is cold, the extract air will be cooled down below its dew point, and condensate precipitation will result. It is therefore necessary to have a drip tray provided with a drain connection below the extract air section. Due to the risk of water entrainment, a droplet separator should be fitted on the exhaust air side for velocities higher than approx. 3 m/s. A drip tray may also be needed on the supply air side, if the humidity is high. The heat exchanger is often equipped with a by-pass of outdoor air to be able to regulate the supply air temperature and prevent frosting. To achieve an appropriate pressure drop the plate pitch varies with size of heat exchanger.

### Frosting and defrosting

Condensate may freeze to ice when the outdoor temperature has dropped below approx.  $-7^{\circ}\text{C}$ .

Several methods can be used for preventing clogging:

- Section-by-section, continuous defrosting below a specific outdoor temperature.
- By-pass of the outdoor air so that the exhaust air temperature will always be above zero and no ice can form.
- Switching-off of the supply air fan until the ice has melted.

Section-by-section defrosting is an effective method.

The supply air side of the heat exchanger is divided into sections (2 to 4). These sections are then closed in sequence and the heat exchanger melts the ice that has formed in the extract air passages of the section. The supply air flow will decrease marginally during section-by-section defrosting. The efficiency will also decrease depending on how many sections there are. The efficiency will decrease by approx. 10%, if there are four sections, because the flow balance in the active section has changed.

The decrease will be 50% if there are 2 sections.

Another method is to prevent frosting by using a by-pass damper. The damper is modulation controlled, so that the exhaust air temperature at the cold corner will never drop below  $2^{\circ}\text{C}$ , for example. With this method, the efficiency is limited to 20 - 25 % if the outdoor air temperature is low and the same mass flow on supply and extract air side.

### Leakage

Plate heat exchangers can be very tightly built, and their leakage is less than 0.5 % for a pressure differential of 400 Pa. If we then see to it that the pressure is higher on the supply air than on the extract air, there will be no transfer of gases or particles from the extract air to the supply air.

### Corrosion protection

Epoxy coated sheet aluminium is used in highly corrosive environments where corrosion protection of the plate heat exchanger is needed.

## Liquid-coupled systems

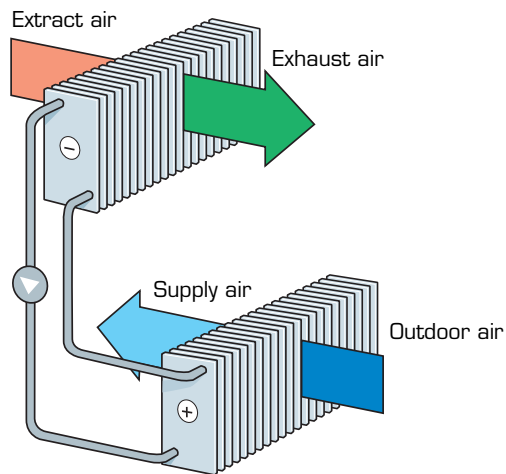

### Design

A liquid-coupled system consists of heat exchangers in supply air and in the extract air. The product names of the Fläkt Woods' liquid-coupled systems are ECOTERM® and ECONET®. Water with an anti-freeze additive is used as the heat conveying medium, which is pumped around and which transfers heat from the warm coil to the cold one. The heat exchanger on the warm side should normally be equipped with a stainless drip tray, which receives condensate, and if needed the coil can also be equipped with a drop-let separator. The heat exchangers are composed of copper pipes with profiled aluminium or copper fins. The fin pitch is normally 2 mm. The water circuit has a pump and a controller with a 2 or 3-way valve (ECOTERM®) or frequency-controlled pump (ECONET®) for regulating the capacity and frost control. Liquid-coupled heat exchangers are available for systems with air flows ranging from small and up to very large. In most cases several capacity variants are available for each size, i.e. coils with various number of tube rows. Air heat exchangers should be connected so that the mode of connection is for counter-flow.

### The system

A liquid-coupled system has some valuable characteristics, which distinguish it from the other systems:

- The supply air and extract air flows are effectively separated from one another no leakage between them can take place.
- Due to its flexibility the system can be used in units where

supply air and extract air ducts cannot be arranged to converge at one point.

- The system is relatively simple to install in existing units.

### Efficiency

The temperature efficiency is mainly dependant on the number of tube rows, which means high efficiency must be paid for with high pressure drop. As a rule of thumb one can expect 50 % with 6 tube rows, 55 % with 8 and 60 % with 10 tube rows.

### Regulation and frost control

#### By-pass

This regulation implies that the heat conveying medium can bypass the supply air heat exchanger. By controlling the by-pass flow you can reduce the amount of recovery. You can also ensure that the temperature downstream of the extract air heat supply never becomes so low that frosting can take place. This regulation principal can be used in systems with several air heat exchangers, if these always operate in parallel.

#### Flow regulation

This is used in larger systems with several supply air heat exchangers if individual regulation is required. In the ECONET® system, a combination of by-pass and flow control is used for reducing the degree of recovery and for anti-frost protection.

### Anti-frost protection medium

The anti-frost protection medium offers security if the pump should stop and also offers security for recovery under low temperature conditions. Liquid mixtures containing an anti-freeze agent always has a negative influence on efficiency. Every 10 % of e.g. ethylene glycol mixed into the liquid, reduces the efficiency by approx. 1 percentage unit. A glycol concentration of 15 % is theoretically enough, but in order to have a certain margin, a 30 % mixture of glycol is recommended.

## ECONET<sup>®</sup>-system

In the patented ECONET<sup>®</sup> concept, all the energy functions are integrated into a common circuit for heat/cooling recovery, heating and cooling. This requires fewer components in form of heating/cooling coils, pumps, valves, pipes, insulation, etc. The result is a shorter and more compact unit.

When heat and cooling recovery is not enough, heat or cooling energy is conveyed to the supply air coil. Excellent heat recovery is obtained because the coil on the supply air side is of a larger size (10 – 12 tube rows) making it extremely efficient, and because the coil can use low temperature water as supplementary heat. Waste heat and surplus cooling energy can be utilized to a greater extent.

Earlier in the chapter about liquid-coupled systems, we mentioned that the pressure drop becomes high if a coil with 10 tube rows is used, but this is compensated in ECONET<sup>®</sup>-systems because no extra air heater or air cooler is required, since these are integrated into the system.

The ECONET<sup>®</sup>-system consists of two or three heat exchangers, i.e. one or two coils in the supply air unit and one in the extract air unit. Two coils are used in the supply air section, when one air heater is desired as protection for the outdoor air filter. In this solution both the supply air and outdoor coil can be utilized for recovery, which makes the system more efficient and simpler than traditional solutions. A pump unit consisting of pump unit and control function for optimising the energy recovery is also included in the delivery. All necessary sensors in the pump unit, the software and project-based parameters in the frequency inverter and the control cubicle are factory-installed.

The pipes in the pump unit are insulated and the pump unit is mounted vertically on its own stand. ECONET<sup>®</sup> can be supplemented with efficiency measurement and can be equipped with two pumps.

### How the system operates

**Heat recovery:** The system optimises the liquid flow in the coils to obtain the best possible heat recovery. The liquid flow is regulated by the frequency-controlled pump.

**Heat recovery + extra heat:** The system optimises the liquid flow in the coils, in order to obtain best possible heat recovery. Extra heat may be added to the circuit, either directly or via a heat exchanger.

**Cooling energy:** The extract air coil is disconnected and additional cooling energy is conveyed to the circuit, so that the cooling liquid circulates through the supply air coil only. Extra cooling energy is directly conveyed to the circuit or via a cooling coil.

**Cooling recovery (e.g.: IEC):** The extract air is cooled by means of humidification through indirect evaporative cooling (COOLMASTER<sup>®</sup>).

The cooling efficiency is transferred to the supply air via the recovery system. The liquid flow is optimised and extra cooling energy can be added when needed.

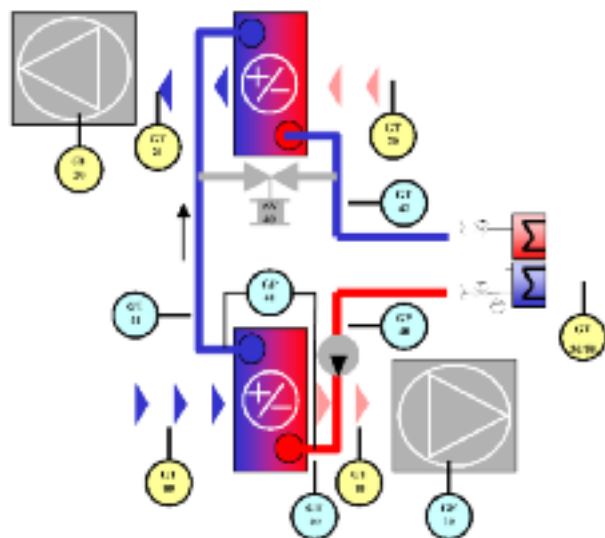

## Temperature efficiency and pressure drop

Temperature efficiencies and pressure drop for the three systems are shown in the table. The comparison has been made for installation in the same air handling unit. The rotor casing may for certain cases, be larger than the casing in the air handling unit.

	Temperature efficiency, %	Pressure drop, Pa
Rotary heat exchanger	75	150
Plate heat exchanger	58	150
Liquid-coupled <sup>1)</sup> , ECOTERM® 6 tube rows	50	210
Liquid-coupled <sup>1)</sup> , ECOTERM® 8 tube rows	55	270
Liquid-coupled, ECONET®	65	330 <sup>2)</sup>

1) 30% ethylene glycol  
2) The total pressure drop for the whole system will not become high because the air heaters and air coolers are integrated in the ECONET® system.

## System comparisons

The chart shows a comparison of the various systems with regard to a number of system factors.

	Rotor	Plate heat exchanger	Liquid-coupled system, ECOTERM®	Liquid-coupled system, ECONET®
Efficiency	++	+	-	+
Pressure drop	+	+	-	+
Power savings	++	+	+	+
Air leakage	-	+	++	++
Space required	+	-	+	++
Running of ducts	-	-	++	++
Control	+	+	+	+
Odour transfer	-	+	++	++
Frost problems	++	+	+	+
Moisture transfer	++	-	-	-
Cooling recovery	++	+	+	+
Environment durability	+	+	++	++
Reliability	+	+	+	+
Surplus heat/cooling energy	-	-	-	++

++ denotes very good qualities  
+ denotes good qualities  
- denotes less good qualities

The factors among those listed above that are to be considered of greatest importance, are conditional on the conditions present in the individual application.



## Summary



Heating and cooling energy recovery are a means of saving, from an economical and an environmental perspective.

### Duration chart

A duration chart shows the outdoor temperature duration for a certain location during an average year. From the chart, you can read the annual heat demand, without heat exchanger for continuous operation and the demand when utilizing a heat exchanger.

### Efficiency

Efficiency is a measurement on effectiveness with regard to energy consumption and is specified in %. There are a variety of systems for the recovery of energy, the totally dominating systems are:

- **Rotary heat exchangers**

The rotor has a very high efficiency (for a given pressure drop) compared to other recovery systems. Hygroscopic rotors also reducing need for humidification.

The temperature efficiency is regulated by changing the rotor speed. The drive apparatus has a motor for variable or constant speed, transmission and drive belt. The control equipment controls the rotor speed.

A purging sector is used for preventing extract air from being carried over by rotation to the supply air side.

When the outdoor temperatures are low, condensation will be precipitated on the extract air side, which later normally evaporates on the supply air side. If the moisture content in the extract air is high and the outdoor temperature is very low, the rate of condensation will be greater than that of evaporation and surplus water will accumulate in the rotor. If the mean temperature during the revolution is lower than 0 °C, the water will freeze to frost and a system for defrosting will be required.

- **Plate heat exchangers**

Plate heat exchangers consist of a number of square, parallel plates. Warm air and cold air flow in every other air passage between the plates and the heat is transferred through the plates.

The plates are thin and are made of a heat con-

ducting material so that the air-to-air heat transmission coefficient will be substantial. The temperature efficiency is considerably lower than that of the rotary heat exchanger.

If the outdoor air is cold, the extract air will be cooled down below its dew point, and condensate precipitation will result. It is therefore necessary to have a drip tray provided with a drain connection below the extract air section.

Condensate may freeze to ice when the outdoor temperature has dropped below approx. -7 °C. Several methods can be used for preventing clogging:

- Section-by-section defrosting
- By-pass of the outdoor air
- Switching-off of the supply air fan

Plate heat exchangers can be very tightly built. If we then see to it that the pressure is higher on the supply air than on the extract air, there will be no transfer of gases or particles from the extract air to the supply air.

- **Liquid-coupled heat exchangers**

The liquid-coupled system consists of heat exchangers in supply air and in the extract air.

Water with an anti-freeze additive is used as the heat conveying medium, which is pumped around and which transfers heat from the warm coil to the cold one.

A liquid-coupled system has some valuable characteristics, which distinguish it from the other systems:

- No air leakage from the extract air to the supply air
- It can be utilized where supply air and extract air ducts cannot converge to one point.
- It is simple to install in existing air distribution systems.

There is one liquid-coupled system variant called the ECONET®. In the ECONET® concept, all the energy functions are integrated into a common circuit for heat / cooling recovery, heating and cooling. With this system, fewer components are required in the unit. The result is a shorter and more compact unit.



# Humidifiers



### The chapter deals with the following



- General details about humidifiers
- Contact humidifiers
- Steam humidifiers
- Nozzle humidifiers

Healthy people are relatively insensitive to variations in humidity in the air. At temperatures ranging between 20 – 22 °C, the relative humidity varies between 30 and 65 % without someone feeling discomfort. As the temperature rises, our sensitivity to low humidity also increases.

High room temperature in combination with low humidity causes our skin, eyes and mucous membranes to become dry. The risk of infections increase and we feel discomfort. For the rest, it is important to know that humidity below 50 % can give rise to electrostatic charges in synthetic flooring and that many industrial processes require a lowest relative humidity of 45 – 50 %.

Hygienic aspects are important when it comes to air humidification. Unsuitable use of equipment, insuffi-

cient care and maintenance, can in extreme cases create health problems owing to that bacteria e.g. legionella, algae, mould, etc. can grow in the system and be spread with the supply air to the premises.

In premises where there is a heating load, the cost for humidifying air is substantial. If there is a need for cooling, evaporative humidifiers can be used for lowering the temperature.

## Humidification principles

Humidification can take place either by supplying steam with a steam humidifier or by allowing the air to come into contact with the surface of a liquid so that the water evaporates, so-called evaporative humidification.

In steam humidifiers, energy that is bound in the steam is supplied to the air. In the evaporative humidifiers, energy is taken from the air to evaporate the water.

Evaporative humidifiers are available in two designs: contact and nozzle humidifiers. In contact humidifiers, a large contact surface is created between the air and the water by means of wet contact fills. In nozzle humidifiers (air washers) atomized droplets are created which evaporate in the air stream.

## Contact humidifiers

In contact humidifiers, water evaporates from wet, unheated humidifier fills. What drives the process is the difference in vapour pressure between the air near the surface of the water and the free air stream. The energy for evaporation is taken from the air. The temperature of the air then drops 2.5 °C per gram humidification.

The function of the contact fill is to form a large contact surface between the air and water. The material in the fills is aluminium, which has been hygroscopically treated to give it a wetting surface, or micro glass.

The surfaces are designed with a structure that steers the water toward the upstream side in order to balance the condition that the air presses the water downstream.

## Operation

The contact fills are sprinkled from above by means of spray pipes, for instance. The water runs down and wets the entire surface. As a rule, a smaller portion of the water evaporates whereas the main portion reaches the water tray beneath the contact fills.

There are two systems for wetting the fills:

- Once-through water system
- System with circulating water

In the once-through humidifier, the water runs from the water tray directly out the drain to the sewer. Tap water is used for wetting the fills. The once-through humidifier meets high requirements on hygiene, but its water consumption is relatively high.

In humidifiers with circulating water, a pump is used in the water tray to pump the water up to the spray pipes. The tap water always contains a certain amount of minerals and salts. It is therefore necessary to bleed off the water from the system in order to prevent a concentration in the water and the precipitation of minerals on the humidifier fills.

If the velocity of the air flowing through the humidifier is high, the droplets can leave the surface and be entrained by the air stream. Aluminium fills can manage a face velocity of at least 3.0 m/s without releasing droplets. A droplet separator must be used for higher air velocities. The maximal permissible air velocity is 4.0 m/s. The operating principle for humidifiers with circulating water is illustrated in the figure to the right.

## Hygiene

Contact humidifiers are very hygienic:

- The water is held together in a water film on the humidifier fills and do not release aerosols.
- The condition downstream of the humidifier does not become saturated which minimizes the risk of condensate precipitation downstream.

If the application calls for extremely high hygienic requirements, a humidifier for once-through water should be used.

## Control

Contact humidifiers are controlled by means of the following:

- On/off control
- The humidifier is divided up in steps ( by-pass )
- Dew point control

For on/off control a hygrostat is placed in the extract air duct or in the room in order to avoid excessively short running times. If higher requirements must be met, multi-step control in two or more steps can be used. If very high requirements must be met, dew point control will have to be tackled.

This involves first humidifying the air in order to reach a humidity that exceeds the water content desired. Then the air is cooled to the correct dew point temperature.

Finally the air is heated to the desired temperature.

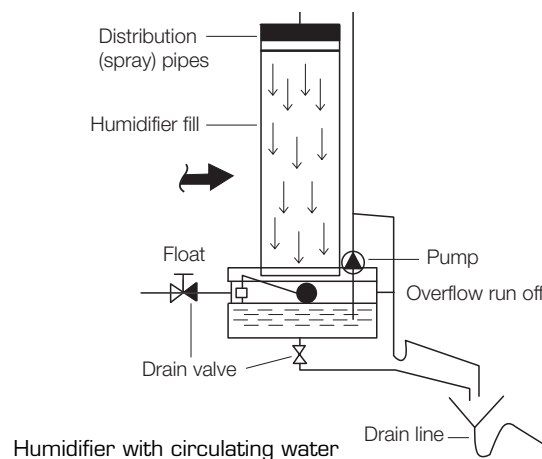

## Steam humidifiers

In steam humidifiers, steam is supplied to the air via so-called steam lances positioned in the air stream.

Steam humidifiers are characterized by the following:

- Humidification can occur without essentially changing the temperature of the air
- The air can be humidified anywhere in the duct system
- Lime and salts are separated from the air as steam is produced
- Simple and quickly modulating control
- Negligible air resistance

A typical steam humidifier terminal is shown in the figure to the right. It is important that the air is not saturated with steam which would otherwise give rise to condensation in the ducts and cause hygienic problems. It is also important to provide sufficient distance from the steam lances to the nearest component in the system. Condensation will otherwise form on the component. When the steam is blown into the duct, droplets are first

formed which later evaporate so that condensation will not occur in downstream components. Electric power is required for producing steam. The steam humidifier normally also requires water treatment.

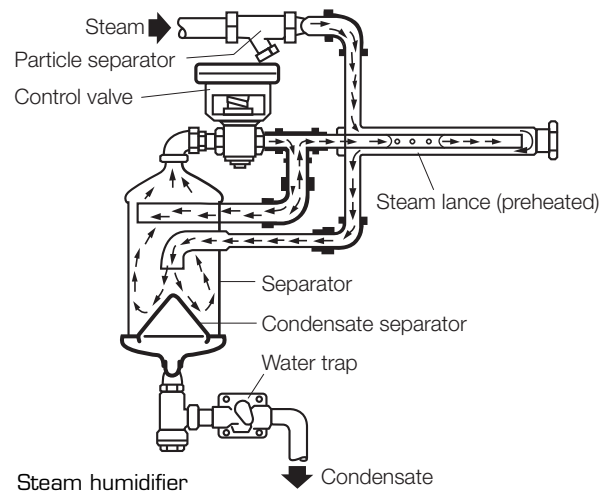

## Nozzle humidifiers

Nozzle humidifiers have a chamber with a number of nozzles that spray fine jets of water upstream toward a dewatering fill. A robust pump generates a relatively high pressure in the nozzles that provides thin jets which break apart into droplets. Droplet separators are positioned downstream of the nozzles.

Just as in the case of contact humidifiers, it is important to bleed off the water in order to minimize the concentration of minerals in the water. When the water is atomized into droplets that evaporate, impurities in the droplets can be transferred to the air. This is a substantial disadvantage with nozzle humidifiers and can give rise to troublesome dust deposit and hygienic problems if the water contains bacteria.

## Water quality

With regard to the function and useful life of the contact fills, the fresh water should be of drinking quality and have a pH of between 5.0 and 8.0.

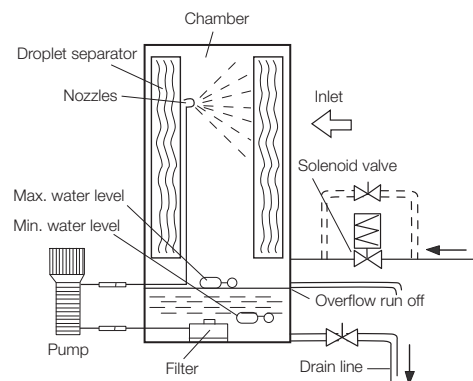

## Summary



Air humidification can take place either by supplying steam to the air by means of a steam humidifier or by letting the air come in contact with the surface of a liquid so that the water evaporates, so-called evaporative humidification. Evaporative humidifiers are available in two designs: contact humidifiers and nozzle humidifiers.

### Contact humidifiers

In contact humidifiers, water evaporates from wet, unheated humidifier fills. What drives the process is the difference in steam pressure between the air near the surface of the water and the free air stream. The energy for evaporation is taken from the air. The temperature of the air then drops 2.5 °C per gram humidification.

The function of the contact fill is to form a large contact surface between the air and water.

The material in the fills is aluminium, which has been hygroscopically treated to give it a wetting surface, or micro glass.

The surfaces are designed with a structure that steers the water toward the upstream side in

order to balance the condition that the air presses the water downstream. The function of the contact fill is to form a large contact surface between the air and water.

### Steam humidifiers

In steam humidifier, steam is supplied to the air via so-called steam lances positioned in (the duct) the air stream. It is important that the air is not saturated with steam which would otherwise give rise to condensation in the ducts and cause hygienic problems. It is also important to provide sufficient distance from the steam lances to the nearest component in the system. Condensation will otherwise form on the component.

### Nozzle humidifiers

Nozzle humidifiers have a chamber with a number of nozzles that spray fine jets of water upstream toward a dewatering fill. A robust pump generates a relatively high pressure in the nozzles that provides thin jets which break apart into droplets.





# Controls



## The chapter deals with the following

- General particulars on control
- Dynamic properties/Time delay In control systems
- Various types of controllers/control principles
  - PID control
  - Cascade control
  - On-off control
  - Multi-step control
- Temperature control
- Air flow/pressure control
- Anti-frosting protection
- Outdoor air compensation
- Night-time heating
- Night-time cooling
- CO<sub>2</sub> compensation
- Alarms
- Communication



In order to understand the content of the pages that follow, it will be of benefit to be familiar with the basics on how the components of an air handling unit are controlled and regulated.

To show this, we shall make use of a block diagram, which shows a closed-loop system, i.e. a system with feedback.

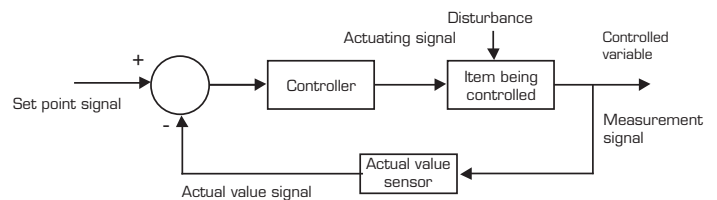

Some form of disturbance have an effect on the control object. A sensor (actual value sensor) reads the regulated quantity, such as temperature, transmitted from the system being controlled. This value, the actual value, is the value that comes from the component just now. The actual value is transmitted to a point of comparison in the system. A signal representing the required value also comes to this point. If the signals do not agree, an error signal is transmitted ahead to the controller which controls to the correct value.

How can we now translate this to describe what occurs in an air handling unit?

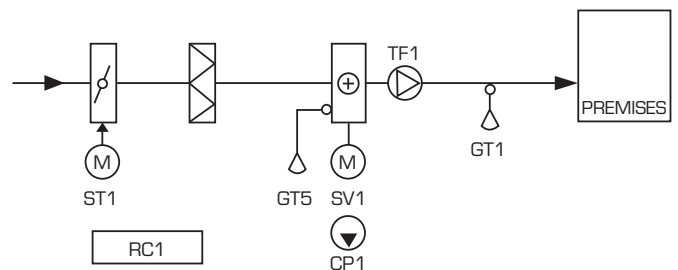

The most important reason why an air treatment system is controlled is to create a comfortable indoor climate. The room temperature and the extent to which a room is ventilated, i.e. a measure of the air change rate in the room, are the factors that affect indoor climate the most. Because of this must the air temperature and air flow from the air handling unit be controlled.

Since we always want to minimize the amount of energy consumed by the air treatment system, the control system must be designed to manage this task. It is also necessary to protect and maintain the air treatment system. This is why the controls have to be equipped with monitors and alarms.

The variable to be controlled in this example is the temperature and the component to be controlled is the air heater. Temperature sensor GT1 (the actual value sensor) reads the temperature in the air just now (the actual value). The actual value is transmitted to controller RC1 which knows the set point, controls to the correct temperature and transmits a control signal to the valve actuator (SV1) which either opens or closes the hot water valve.

# Dynamic Properties

Control systems that have the property whereby changes in the input signal take a certain period of time to propagate to the output signal, are called dynamic systems. An example of a dynamic system is temperature control in a room.

When the heating output from the radiators has been increased, it takes a while before the room temperature changes.

To make it easier to see the how long it takes before the temperature changes, the system's dead time, after the heating output has been increased; we dislocate the curves in the chart. The figure below also shows the time constant which corresponds to how long it takes to reach 63% of the final value.

If we take a short time constant the process will be quick, however in most air treatment applications we want the process to be slow.

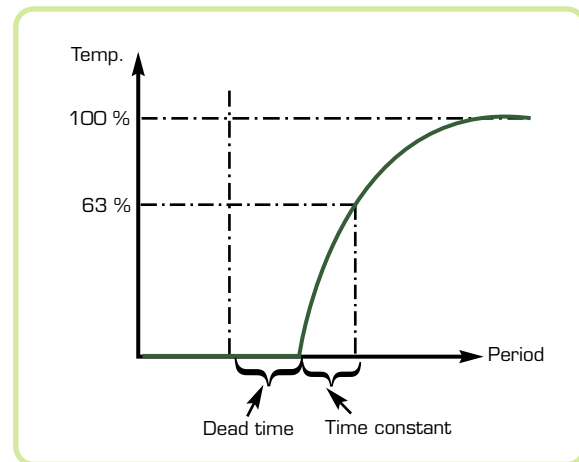
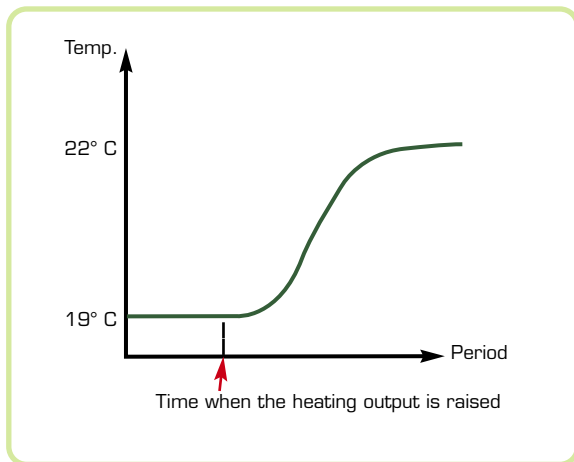
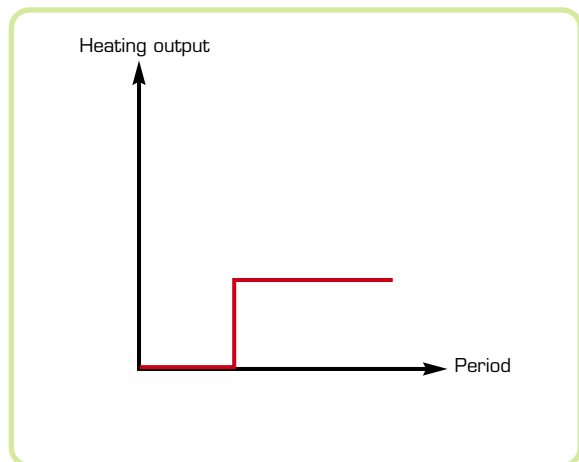
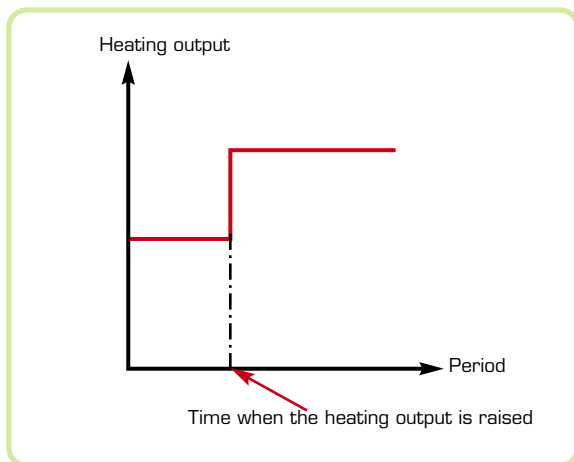
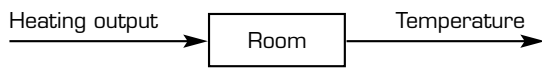

## Various Controllers/Control Principles

---

Short descriptions of the most common control principles are given below:

### On/off control

On/off control is the simplest form of control. All that is needed is an apparatus that can reverse the control signal depending on whether the control system's output signal is stronger or weaker than the output signal, e.g. a thermostat.

The controller therefore switches on or off depending on the error signal, the difference between the feedback value and the set point. This is why this control principle is called: on/off-control.

The advantages of on/off control are that it is simple and inexpensive, however its disadvantages are that it can give rise to large oscillations in the control system, see figure below, and can cause mechanical wear and tear on the controller.

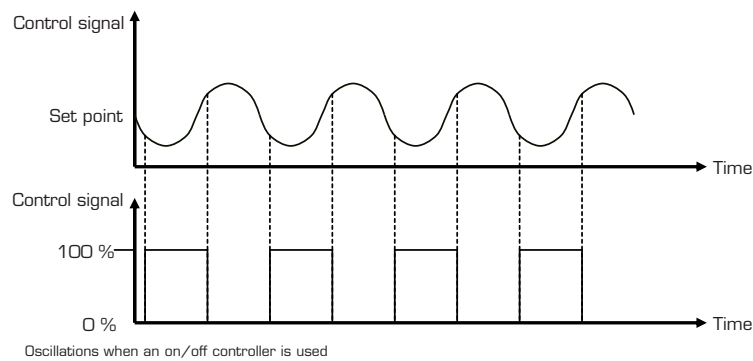

---

### Multi-step control

The multi-step controllers have several steps instead of only two like the on and off controller. The oscillations in this control system are therefore not as large as they

are in an on/off control system. Multi-step control is often used in electric air heaters and coils with DX cooling as well.

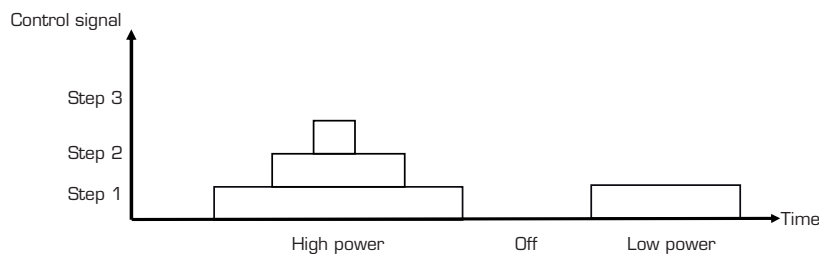

### Proportional control (P control)

For proportional control, the control signal is proportional to the input signal transmitted to the controller, the error signal.

$$u = P \times e$$

Where

$u$  = The control signal

$P$  = Gain

$e$  = The error signal

If  $P$  is low, we obtain a stable but slow control, whereas if the  $P$  value is high, the system will be fast but its oscillation rate will be high. See the chart below.

Proportional control (P control)

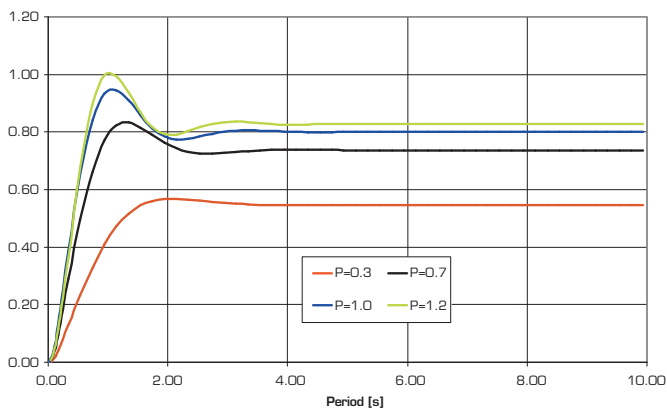

The amplification's effect on the control signal

A disadvantage of the P-controller is that we never reach the set point.

### Integral control (I control)

When integral control is used, the strength or velocity of the output signals is contingent on the size of the error signal.

The output signal from the controller is the integral of the error as follows:

$$u(t) = \frac{1}{T_I} \int_0^t e(t) dt$$

Where

$u(t)$  = The output signal from 0 to  $t$

$T_I$  = The integration period

$e$  = The error signal

If a control error arises, the control signal will decrease or increase. When the error later disappears, the control signal will become stable and constant at its new value.

### PI control

P and I control are most often combined and this then is called PI control. The PI controller is the most common type of controller.

This control method combines the advantages of both types of controller.

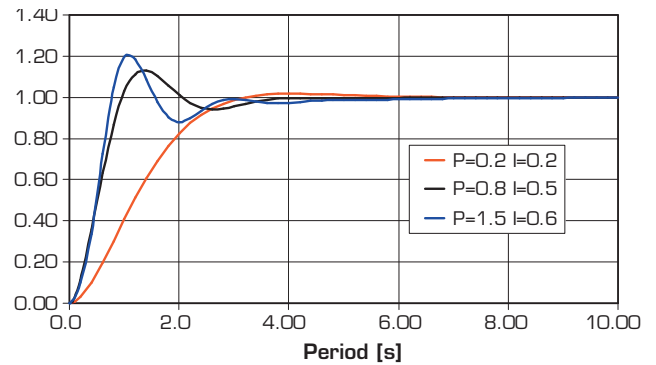

The amplification and the effect on the control signal

### PID control

The D stands for the derivative part. The output signal from the D block is conditional on the derivative of the input signal.

Derivative control never occurs alone but is always used together with PI control or P control. The task of D control is to stabilize the system.

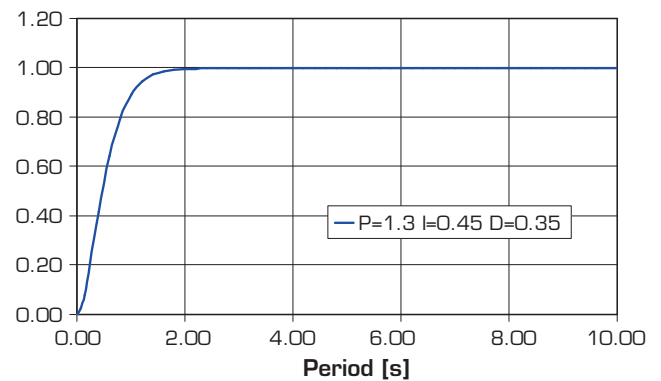

### Cascade control

Cascade control is used when the control process can be divided up into several blocks and where disturbances come from several sources. See the figure below.

This type of control is often used in air treatment systems.

The set point of the inner feedback loop can be limited.

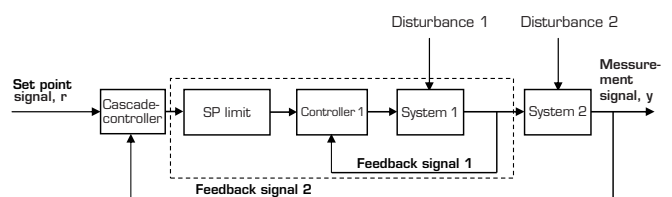

Controller 1 has the task of reducing disturbance 1 so that it will not have a strong effect on system 2.

## Control unit in air handling units

The main task of the control unit is to control the properties of the air being conditioned, manage how the air handling unit is operating and monitor the event of possible alarms. Examples:

### Main functions

- Temperature control
- Air flow/pressure control

### Extra functions

- Anti-frosting protection
- Outdoor compensation
- Night-time heating
- Night-time cooling
- CO<sub>2</sub> compensation

## Temperature control

The task of the control unit is to regulate the temperature of the supply air to the required temperature. The temperature can be regulated by employing one of three basic methods:

### Supply air control

This method involves placing a temperature sensor in the supply air duct and wiring it to the control unit of the air handling unit.

The desired supply air temperature is preset as a set point in the control unit. The supply air controller then controls e.g. the heat exchanger and the air heater to meet the amount of heat required in the supply air.

Supply air temperature control is well suited for use if the air handling unit supplies air to a number of rooms. Normally relatively cool air is supplied to the rooms and the radiators of some other heat source are used for controlling the temperature in the rooms.

### Extract air control

When supply air temperature control is used, the control unit receives no feedback for either room temperature or extract air temperature and therefore has no knowledge of what the temperature in the rooms really is. This can be improved by installing temperature sensors in both the supply air and extract air ducts. The extract air temperature provides a good mean value for the temperature in the rooms. The control unit regulates the supply air temperature to an appropriate level, for keeping the extract air temperature at the desired level. The method is well suited for ventilation systems that supply air to a number of similar rooms. In some applications, in which the rooms have very different heating demands, this method could be inappropriate since the temperature may be too low in one room and too high in another. The control unit in the air handling unit will not perceive this difference, but instead can only read the average temperature. Supply air temperature control would be much better in such applications.

Used for the control of coils with DX cooling.

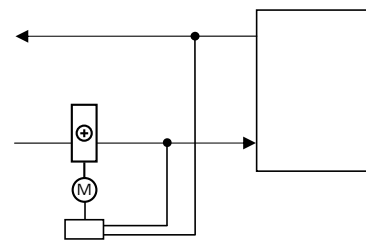

Basic diagram showing the extract air control principle

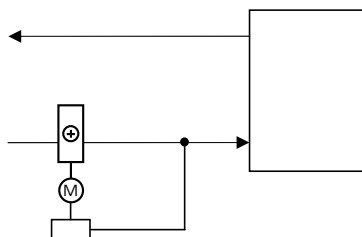

Basic diagram showing the supply air control principle

### Room control

Room control provides the best control of temperature in a specific room and is used where the air handling unit serves this room only. A temperature sensor is installed in the room. There is often provision for manually adjusting the temperature set point on this room unit. Another sensor is located in the supply air duct. Both sensors are wired to the control unit.

This method is normally appropriate for use in very large rooms only.

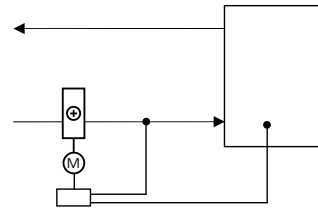

Basic diagram showing the room control principle

## Flow and pressure control (fan control)

Air treatment systems can roughly be divided into two types:

- CAV systems, systems with constant air flow and
- VAV systems, systems with variable air flow.

In a CAV system, the fan is regulated to maintain a constant air flow, whereas in a VAV system, the fan controls to achieve a specific pressure in the duct.

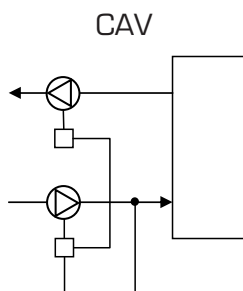

The supply air fan is controlled in response to the duct pressure. The extract air fan is controlled in parallel. The system is simple but variations in pressure may arise in the room.

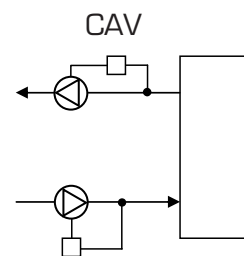

Both fans are controlled in response pressure conditions. The difference in pressure can be utilized for creating a set point for the extract air fan. This method provides better control of the pressure in the room.

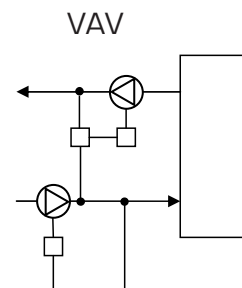

In VAV systems, the supply air fan can be controlled in response to the pressure. The supply air and extract air flows are measured and the difference between these values is used as an error signal for controlling the fan. The supply air flow is thus regulated and the extract air follows.



The air flow from the fan and the pressure generated by the fan is determined by the point of intersection between the fan curve and the system curve. In order to change the flow or the pressure, either the system curve or the fan curve must be changed. The system curve is a function of the pressure drop in the system and to change this curve, the pressure drop must be changed in some way.

The fan curve is a function of the design of the fan impeller and the speed at which it is driven. In order to alter the fan curve we must either change the fan design or change the impeller speed.

Traditional methods involve the following:

- Throttling the air flow by utilizing an air damper (this will change the system curve)
- Inlet guide vanes that change the fan characteristic (this will change the fan curve)
- Control of the impeller blade angle which also changes the fan characteristic (this will change the fan curve).

However now-a-days, speed control is the most common form of control used.

- Frequency inverter (this will change the fan curve)  
The frequency inverter is used for regulating the motor speed, and this gives us a proper method for pressure and flow control. The frequency inverter can be used in both VAV and CAV systems for maintaining the set point for pressure or flow. In some applications, the frequency inverter can be integrated into the motor but its function will be the same. It electronically alters the voltage frequency before it supplies the voltage to the motor. From the fan curve we can see that various fan speeds generate various pressures and flows. Hence by changing the motor speed we can regulate the pressure or flow in the system. Pressure sensors for pressure control of a VAV system are normally located downstream of the fan in the duct, whereas sensors for flow control of a CAV system measures from the fan nozzle, see figure below. The sensor transmits a feedback signal to a PI controller, which either is located in the frequency inverter or in the AHU control unit. In the PI controller, the measurement signal is compared with the current set point. The set point is usually a setting in the controller that was preset while the system was commissioned.

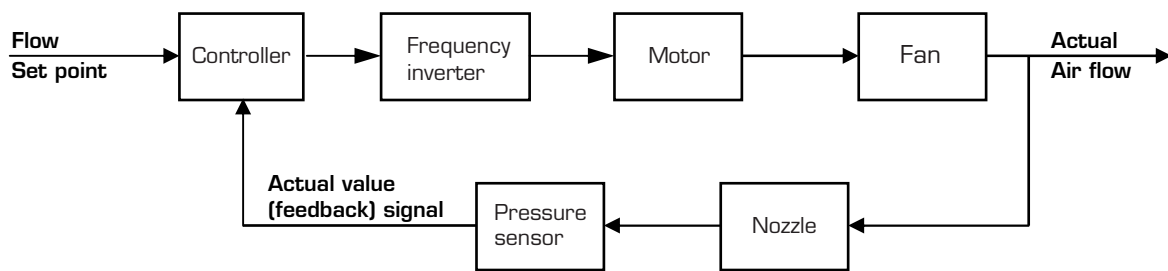

Flow control

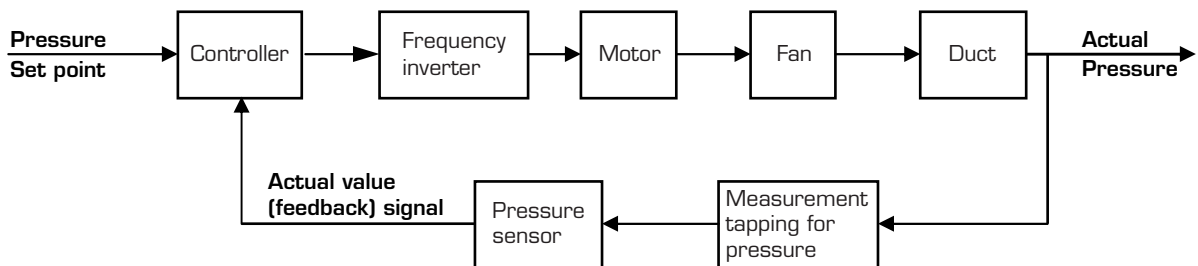

Pressure control

### Sequence control

One of the control unit's most important tasks is to regulate the supply air temperature to an appropriate level. That temperature is usually not equal to the outdoor temperature and normally require either heating or cooling because of this.

In the majority of applications there is also some type of heat recovery system that can be used for heating or cooling the premises. We also want to have energy-efficient control of the temperature, so we need to maximize the use of the heat recovery system. The method used for doing this is called sequence control. See figure below.

The figure shows the output signal from the controller transmitted to various components in air handling unit for various temperatures. In the chart we see that there are two different set points for temperature; one for heating (T2) and one for cooling (T3). These are desired temperatures that have been preset in the control unit. Typical temperatures are 18° C for T2 and 22° C for T3. This means that if the temperature is below 18° C then heating is needed and if the temperature is above 22° C then cooling is needed.

The reason why we have two set points is that the temperature then will be slightly lower in the winter and slightly higher in the summer. This is both energy-efficient and in practice more comfortable for the persons spending time in the building. It is of course possible to set two points to the same temperature, however the closer they are, the higher the costs for energy will be. Assume that the temperature is just above T2.

Neither heating nor cooling is needed and just the fans are running. If the temperature drops slightly to just below T2, the heat recovery system will start and heat will be recovered from the heat sources in the building. If the temperature continues to drop, the output signal transmitted to the heat recovery system will increase, so that more energy will be recovered.

When it reaches 100%, the air heater will be switched on. The heating output will then gradually increase up to 100 % while the heat recovery system operates at 100 %. When the temperature exceeds T3, cooling will be needed. If cooling energy recovery is used, it will operate at 100 % if the outdoor temperature is above the extract air temperature.

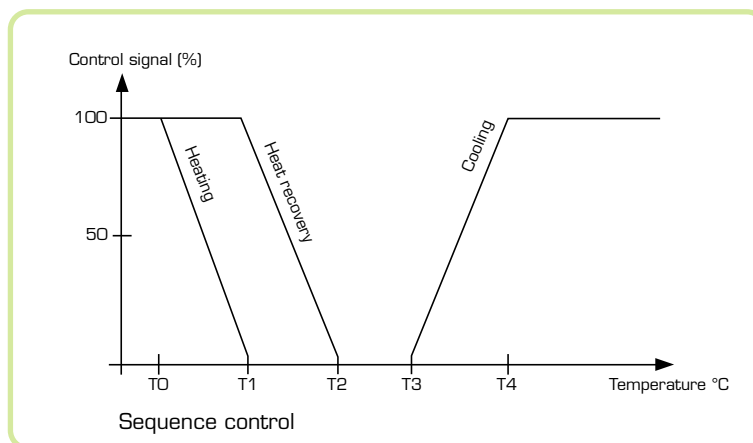

## Examples of control in various HVAC functions



### Rotary heat exchanger

If a rotary heat exchanger is used we need only regulate the speed of the rotor drive motor as a means of regulating the air temperature. The chart shows that the efficiency of the rotary heat exchanger is a function of the rotor speed and the efficiency in turn is of course the relationship between the different temperatures in the air handling unit. Control of the motor speed is also used for defrosting the rotor.

$$\eta = \frac{t_{\text{supply air}} - t_{\text{outdoor air}}}{t_{\text{exhaust air}} - t_{\text{extract air}}}$$

Where

$t$  = the temperature of the various air flows



### Plate heat exchanger

The temperature is controlled by means of a damper when a plate heat exchanger is used. To achieve the correct temperature, a portion of the air is allowed to bypass the heat exchanger and this flow is regulated by means of the damper. The damper is also used for defrosting the plate heat exchanger.

There are two main methods of defrosting the heat exchanger:

- Bypass defrosting
- Section-by-section defrosting

When bypass defrosting is used, the bypass section of the plate heat exchanger is opened while the front damper is closed. This reduces the temperature efficiency of the heat exchanger and the frost can then melt. When section-by-section defrosting is used, each individual damper blade on the heat exchanger is closed, one at a time in sequence.

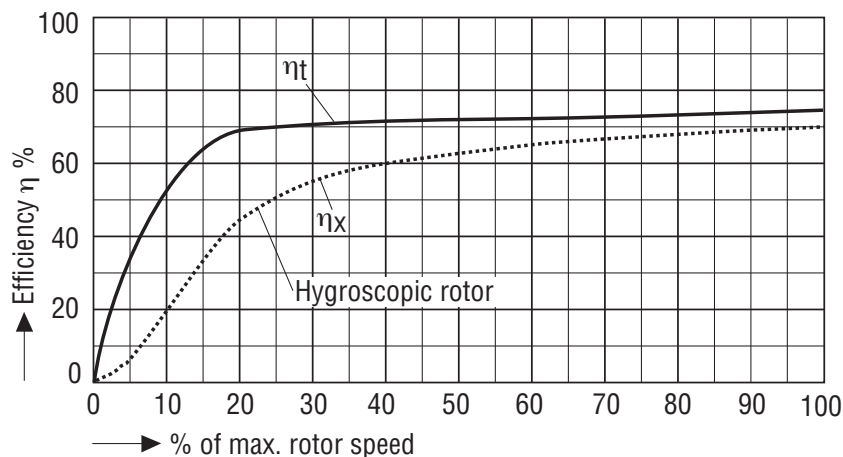

### Liquid-coupled heat exchangers

The temperature is regulated either by shunting some of the water past the extract air coil which reduces the volume of energy being recovered from the extract air. The other method involves regulating the speed of the pumps instead.



### Heating and cooling coils

There are a number of ways to control the heating capacity of the coil, which involve control, either of the water flow, of the water temperature or of both. The main methods used are the following:

- Water flow control by means of a valve.
- Bypass control by means of a secondary circuit pump and valve.



### Water flow control

Hot water is supplied from a central boiler and is pumped around a water circuit in the building by a central pump. The pressure in the system is sized to be high enough to force the water through a various number of heat exchangers as well as the actual circuit. The simplest method used is the use of a two-way valve, which throttles the water flow in the circuit.

Using a three-way system, a higher temperature on the water side can be maintained for partial loads, which is desirable in oil-fired or gas-fired boiler plants. Low return temperatures cause condensation from flue gases which can cause corrosion in the boiler plant.

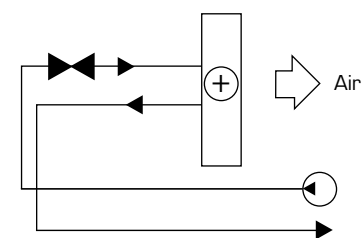

Two-way valve

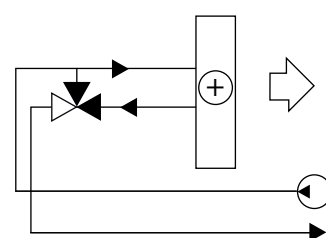

Three-way valve

### Shunt control

A shunt pipework package is the link between a primary and a secondary system in a water-based heating and cooling system, for example between the boiler (primary circuit) and radiator system (secondary circuit).

The secondary system operates often with other temperatures and flows than the primary. The pipework package is mounted between these two and mixes the media (primary / secondary) in a controlled manner by means of a pilot valve and valve actuator so that the correct temperature will be obtained in the secondary system. The circulation pump ensures that the correct flow is circulating in the secondary system.

A pipework package consists of the components below:

- Pilot valve that regulates the flow in the primary and secondary circuits of the pipework package. The pilot valve is controlled by an actuating motor wired to the control unit in the building. The pilot valve is of 2 or 3-way design depending on the pipework coupling option.
- Circulation pump that maintains the circulation on the secondary side.
- Adjusting valve(s) used for adjusting (balancing) the flow and pressure drop in the pipework package's secondary side and/or primary side in order to achieve an optimal duty point.
- Shut-off valves are mounted on all the water supply and return pipes for enabling the pipework package to be dismantled for service without having to empty the entire system.
- Heat/cooling barriers prevent undesirable energy transfer between the pipework package's primary and secondary systems. These are available in

either a mechanical or thermal version (see the lastmentioned one in the illustration above).

- Bypass enables circulation in the secondary circuit of the pipework package even if the pilot valve is closed toward the secondary circuit (designed with non-return valve in the illustration).
- The non-return valve prevents the medium from circulating the wrong way in the event that the power supplied to the secondary circuit pump should fail.
- Thermometers mounted on the supply and return pipes. These are only for obtaining an overview of the bypass pipework package shunt unit's current operating mode and ensure that the system is operating properly.
- Measurement tappings mounted on each pipework package are provided for complete inspection and troubleshooting.

A constant water flow is maintained in the coils, while the water flow temperature is regulated by means of shunt (bypass) control. This is achieved by installing a pump on the water supply pipe to the coil and a three-way valve in the outlet line, as shown in the illustration below.

By means of this system, a constant return water temperature can be maintained, a requirement that may have to be met if the hot water is supplied from a district heating system. The pump in the shunt connection forces a constant flow of water through the coil and the three-way valve mixes a portion of the primary hot water with a portion of the cold return water from the coil, in order to provide a correct heating output capacity. In all the cases, the actuators wired to the air handling unit's control unit operate the water control valves.

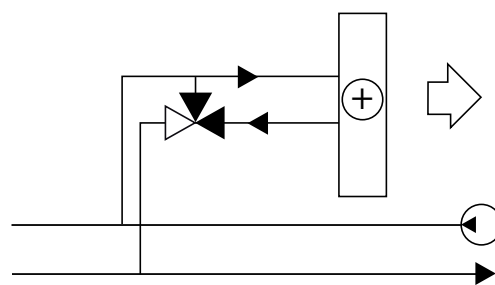

The arrangement of a pipework package



### Electric air heater

In an electric air heater, a stepping switch unit is wired to relays that control the air temperature. A binary system is used for reducing the number of steps needed and in this way keeping the running costs as low as possible.

The capacity steps are arranged each one has double the capacity of the one before it.

For example:

$$1+2+4+8+16+32$$

or

$$3+6+12+24+48$$

This of course means that the temperature tends change in steps, which may be undesirable.

A thyristor control device can be used for providing variable output. This is an electronic temperature control that regulates the output from the air heater by periodically pulsing out full power to the heating elements (so-called Pulse/Pause technique), for example 30 seconds on and 30 seconds off.

This provides very accurate temperature control. The air temperature is conditional on the period between the pulses and the length of the pulses.

For reliability and minimum cost, it is advisable to combine the use of binary stepping controllers with thyristor control on the smallest output steps.

The first step can be controlled all the while between 0 and 1, so if we need 13.65 kW we switch in 0.65 kW (use the thyristor in the first step) + 1 + 4 + 8.

The use of one single thyristor to control the entire output could be very expensive.

## Extra functions

### Outdoor compensation

The set point temperature for supply air or room air can be adjusted up or down depending on the outdoor temperature.

The comfort can be improved both on cold winter days and hot summer days if the set point is set higher. This increase will also save energy in the summer.

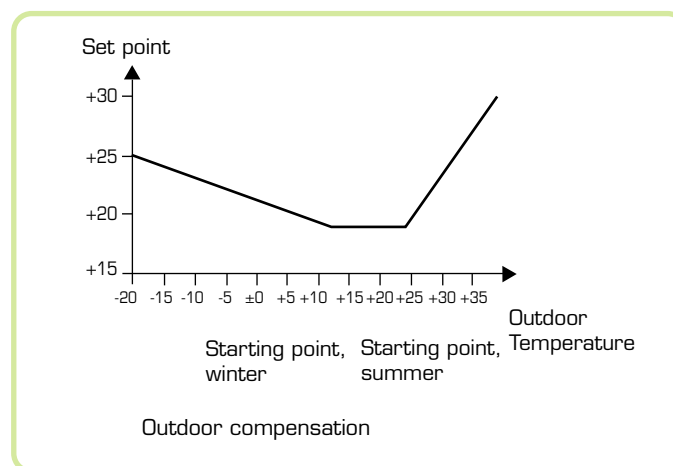

### Night-time heating

Night-time heating is used for preventing the building from cooling down too much at night. This is done in order to ensure the comfort conditions when the system is started up early in the morning, but also for protecting the building and everything it contains.

If the unit is equipped with a heat exchanger, a bypass is arranged so that the supply air fan and the heat exchanger can be operated for providing a circulation of warm air.

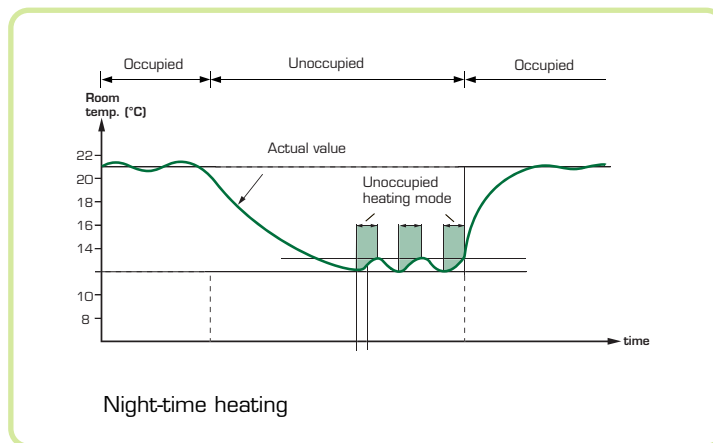

### Night-time cooling (Free cooling)

Night-time cooling is used for reducing the cooling demand when the air handling unit is started up and for limiting the maximum temperature during non-

working hours, by utilizing the free cooling power available during the cool summer nights. The fans are running but no cooling energy is needed.

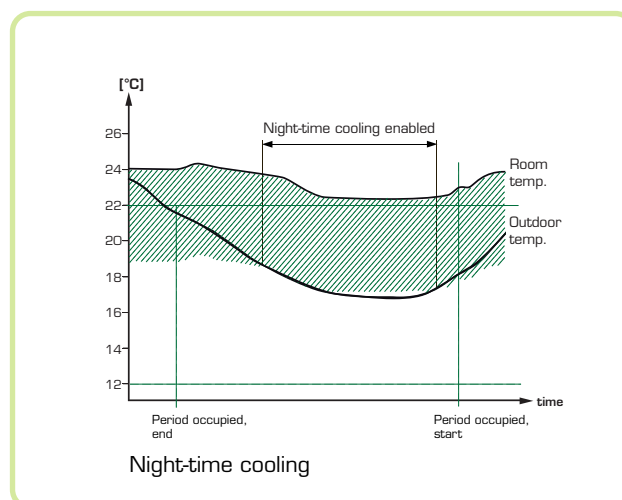

### **CO<sub>2</sub> compensation**

The air flow to the room can be adjusted to a higher or a lower setting depending on the CO<sub>2</sub> content.

### **Operation management**

The control unit is accountable for starting the air handling unit in the correct function sequence, such as to open the dampers and then start the fans.

The control unit can be programmed to start and stop the air handling unit at certain times of the day and to respond to certain conditions, such as low temperature in the building or sense the presence of smoke.

Another function that is often included is to operate the pumps for a few minutes now and then during long periods when the air handling unit is idle.

### **Anti-frosting protection**

It is important to protect the water coils from freezing and bursting when the outdoor temperature is low.

This can be done either by measuring the air temperature near the coil or by measuring the water temperature in the coil.

### **Alarms**

The control unit also manages various alarms.

Alarms are used for indicating when something is wrong

or if servicing is required, such as filter replacement.

The alarms are indicated on the control unit however it is also possible to initiate a general alarm to a higher-level system, for example a main control and supervisory system (SCADA/BMS\*), via communication. \* BMS = Building Management System.

Examples of common alarms:

- Flow monitor

A pressure switch monitors the pressure across the fan and transmits a signal if it drops below a preset limit value.

No air flow may indicate that the fan has stopped due to e.g. a motor malfunction or a broken or slipped off drive belt.

- Filter guard

A filter guard is a pressure switch that monitors the pressure drop across the filter. When the pressure has reached the preset limit value a signal is transmitted to the control unit that then indicates that a filter replacement is required.

Other alarms include anti-frosting protection, thermal overload protection and fire protection.



## Communication

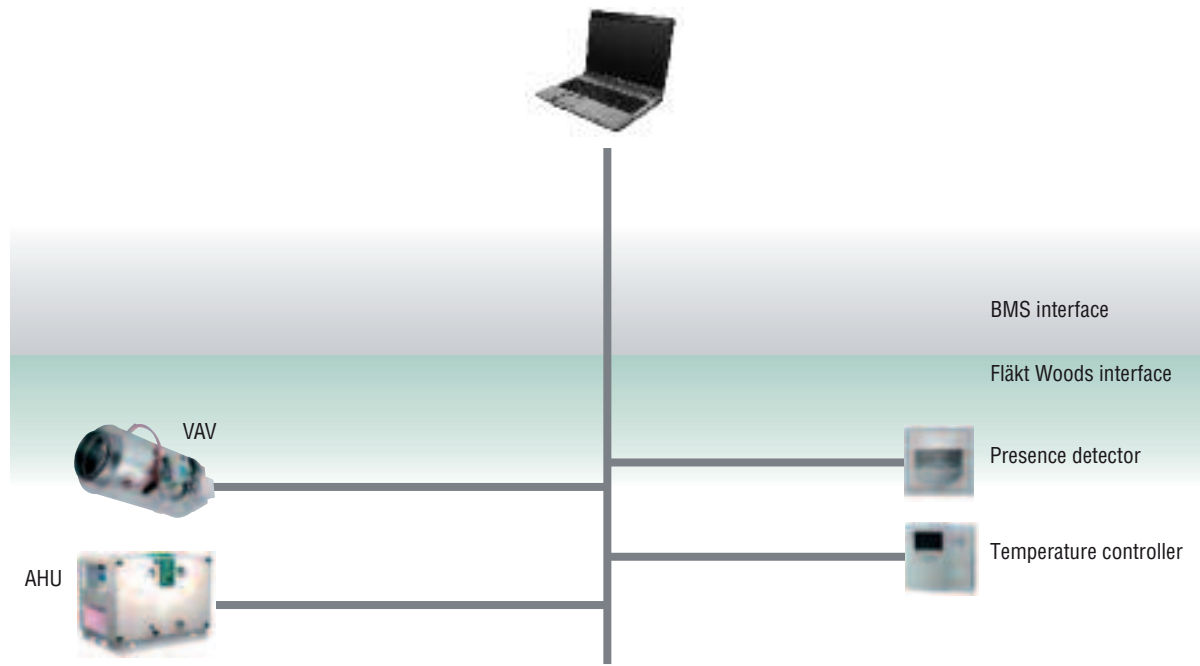

The air handling unit can be included as a component in the automated management system of the building (BMS = Building Management System). A modern automated building management system should be composed of standardized and open communication facilities.

This provides scope for integrating system components of various brands as a means of minimizing costs, and at the same time focuses upon user friendliness and functionality, and this enables us to customize the system to meet the requirements of the client.

Fläkt Woods control equipment can manage the following open communication facilities.

- **BACnet**

BACnet is an open world-wide standard, especially conceived for automated building management. BACnet is connected up via a TCP/IP network.

- **OPC**

OPC is an open industry standard that via a common interface simplifies the integration of various products in the same system.

OPC is connected up via a TCP/IP network.

- **LonWorks**

The Lon circuit card is equipped with automatic transmission of all SNVTs which simplifies commissioning. The LonWorks circuit card is connected up via a Lon network.

- **Modbus**

Modbus is an open industrial de facto standard and is connected up via RS 485 or TCP/IP.

The Modbus circuit card can be configured as either a master or a slave.

- **Web communication**

Now-a-days several controls suppliers offer control units with integrated webserver, which means that no special supervisory software is needed; it is enough to utilize a standard webbrowser in an optional computer in the network (TCP/IP).

## Summary



The most important reason why an air treatment system is controlled is to create a comfortable indoor climate. Since we always want to minimize the amount of energy consumed by the air treatment system, the control system must be designed for managing this task.

It is also necessary to protect and maintain the air treatment system. This is why the controls have to be equipped with monitors and alarms.

Control systems that have the property whereby changes in the input signal take a certain period of time to propagate to the output signal, are called dynamic systems. A typical example of a dynamic system is temperature control in a room. There are various types of controllers/control principles:

- On/off control
- Multi-step control
- Proportional control (P control)
- Integral control (I control)
- PI control
- PID control
- Cascade control

The control unit in the air handling unit has the main task of controlling the properties of the conditioned air, manage how the air handling unit is operating and monitor the event of possible alarms.

### Main functions

- Temperature control
- Air flows/pressure control

### Extra functions

- Anti-frosting protection
- Outdoor compensation
- Night-time heating
- Night-time cooling
- CO<sub>2</sub> compensation

The control unit is also accountable for starting the air handling unit in the correct sequence of functions.

The control unit can also indicate alarms or initiate a general alarm to a higher-level control system, for example a main control and supervisory system (SCADA/BMS\*), via communication.

The air handling unit can be included as a component in the automated management system of the building. A modern automated building management system should be composed of standardized and open communication. Fläkt Woods control equipment can manage the following open communication facilities.

- BACnet
- OPC
- LonWorks
- Modbus
- Web communication

\*BMS = Building Management System

# 18

## Measurement technology and standards



### The chapter deals with the following



- Measurement accuracy
- Temperature measurement
  - Thermocouples
  - Resistance gauges
- Pressure measurement
  - Diaphragm manometer
  - Liquid column
- Calculation of airflows
- Atmospheric humidity
- Standards

Measurement technology or metrology is the Science of weights and measures, a branch of science in physics and electronics that deals with how various physical quantities are measured. This is a very broad scientific domain, and it is extensive and complicated. Typical difficulties that arise are that it is not possible to measure something without in some way influencing the object on which we are taking measurements, disturbances from the surroundings or the measurement of a slight difference between two enormous values, etc.

In the field of air treatment, we take measurements mainly with two purposes in mind: The first is to develop products that offer better performance, to make products more energy efficient, to develop their design, etc. The other main purpose is to produce reference documents for the sizing of products/systems in the form of catalogues and product selection software. These two purposes are pursued in laboratories and in most cases they follow a Standard. This is also done by means of field measurements, which involves products which are component parts of a system. These field measurements are difficult to carry out and most often do not follow any standard.

## Measurement Accuracy

All measurements that are taken include some error. These errors can be divided up into three categories: Measuring instrument errors  $m_1$ , method of measurement errors  $m_2$  and reading errors  $m_3$ . The probable error can be calculated using the following formula:

$$m = \sqrt{m_1^2 + m_2^2 + m_3^2}$$

# Temperature

Temperature measurement is the most common form of measurement and physical parameter which perhaps affects our environment and humanity the most. Accordingly, of all the physical parameters, temperature is also the one that is measured the most and the measurement applications used are the most varying. We measure material in its three states of aggregation - solid, fluid and gas form. This requires measurement equipment with the right design, accuracy and reliability; equipment that will operate properly in various environments. A number of common types of sensors for temperature as well as a few practical aspects concerning their use are described below.

## Thermocouples

The thermocouple utilizes the principle that two metals of dissimilar composition jointed at a point generate electric tension proportional to the differential temperature across the metals. The relationship tension/temperature is rather complex.

Thermocouples are composed in practice of two insulated wires joined at one end (the measuring end). A connector specially designed for its purpose is usually mounted in its other end. A large number of different types of thermocouples with various properties are available. A few very common types in practical use are: J, K and T. See further below.

Type	Material	Colour, contact	Range °C
J	Fe - Cu/Ni	Black (black)	20 -700
K	Ni/Cr - Ni/Al	Yellow (green)	0 - 1100
T	Ni - Cu/Ni	Blue (brown)	- 185 - 300

Thermocouples can be purchased on rolls. The user can then unroll and cut it to an appropriate length and produce his/her own sensor by punching or welding the ends together. There are also jacketed thermocouples of very small dimensions and designed as hand-held probes. Their measurement accuracy is modest; in practice approx.  $\pm 1^\circ\text{C}$  at best. The reference point (cold solder joint) must be measured by the instrument that is used and here there is a big source of measurement errors. Special compensating leads are required for lengthening thermocouples. Criteria for selecting sensors are, among others, mechanical design, temperature range and environment.

## Resistance gauges

Resistance gauges operate according to a different measurement principle as opposed to thermocouples. The resistance gauge is in principle a resistor whose resistance changes in proportion to the temperature. A classic gauge is composed of a metal wire wound upon an insulated body of glass or ceramic material. The metals used are platinum (Pt) and nickel (Ni) for instance. The gauge is in many cases called according to its resistance at  $0^\circ\text{C}$  for example Pt100 ( $R=100\text{ ohm}$ ) or Ni1000 ( $R=1000\text{ ohm}$ ).

The resistance temperature relationship is well known (almost linear) and is defined in various DIN standards in which inaccuracy is also specified. Resistance gauges are too fragile to be used exposed to the surroundings and is therefore usually enclosed in various types of metal tubes. A very common temperature sensor used in industrial applications is probably the Pt100. It is particularly well tested and is produced in large quantities. It is available in a variety of different designs (enclosures) for different applications. Other advantages are known accuracy and long-term stability. A disadvantage of the gauge is its low output signal of approx.  $0.39\text{ ohm}/^\circ\text{C}$ . This means that measuring errors can arise due to the resistance in the connection cable. To solve this problem, a 4-wire coupling is used, which eliminates the effect of the conductor resistance. Pt100 has become the industry standard.

# Pressure & Flow

A few common methods used for measuring pressure are described below. The flow can then be calculated based on pressure measurement readings.

## Diaphragm pressure gauges

This is the type of sensor most often used in practice. In its simplest form, it consists of an elastic diaphragm which moves depending on differential pressure between the inside and the outside. Modern electronic meters use this principle since the displacement of the diaphragm is counteracted by a magnetic coil that regulates the force. Some electronic sensors are not only position-dependent but also are influenced by the supporting surface upon which they are placed.

### Liquid column, U-tube

Liquid columns based on fundamental principles are used in their simplest form. At U-tube is filled with a liquid, if the U-tube has exactly the same diameter its capillary force can be disregarded and the formula for pressure will then be:

$$p = \frac{F}{A} = \frac{\rho \cdot g \cdot h \cdot A}{A} = \rho \cdot g \cdot h$$

Where

$p$  = Pressure, Pa

$F$  = Force, N

$A$  = Area, mm<sup>2</sup>

$\rho$  = Density, mm<sup>3</sup>

$g$  = Acceleration of free fall, m/s<sup>2</sup>

$h$  = Altitude, m

The density of the liquid must be known. The measuring tube can preferably be tilted in order to increase its sensitivity, and then it is necessary to multiply with the angle  $\text{tg}(\varphi)$  in the formula above.



## Calculation of Airflows

The measurement of airflows in the field is admittedly difficult and even in a laboratory an accuracy 5 % figures in as precision measurement. Only under special circumstances can the absolute accuracy be pressed down to 1 - 2 %.

The most common methods are based on either measuring the air velocity at a number of points and summing them up across a certain range or measuring a pressure drop across some type of throttling device.

The most common methods are based on either measuring the air velocity at a number of points and summing them up across a certain range or measuring a pressure drop across some type of throttling device. In a flowing gas or liquid, we calculate on motive energy per volume unit, which then obtains the dimensions of a pressure, the so-called dynamic pressure  $p_d$ .

When air passes through a fan, energy is consumed to increase the dynamic pressure  $p_d$ , however a large portion is used up to compress the air and increase the static pressure  $p_s$ , which can be interpreted as an energy increase per volume unit. The sum of these energies is called total pressure  $p_t$ . The volume flow  $q_v$  is often specified in documents, which are defined as:

$$q_v = A \cdot v$$

Where

$q_v$  = Volume flow m<sup>3</sup>/s

$A$  = Cross sectional area, m<sup>2</sup>

$v$  = Velocity, m/s

In a closed system, the volume flow changes when the gas is compressed, changes temperature and its density then changes and that is when the mass flow  $q_m$  becomes an issue. The mass flow is always constant in a closed system.

$$q_m = \rho \cdot q_v$$

Example:

Common data in documents:

**Density** = 1,2 kg/m<sup>3</sup>

**Pressure** = 101,325 kPa

**Temperature** = 20 °C

**Relative humidity** = 46%

If we measure these on a warm summer day

**Pressure** = 97,325 kPa

**Temperature** = 30 °C

**Relative humidity** = 60%

We then seek the density for these conditions

$$\rho_1 = \rho_0 \cdot \frac{T_0}{T_1} \cdot \frac{P_1}{P_0} \cdot \frac{1+x}{1+\frac{x}{0.622}} = 1.153 \text{ kg/m}^3$$

The effect on density, as we mentioned earlier, changes the volume flow. The percentages given below show the influence various parameters for this example.

**Temperature** = 10%

**Pressure** = 4%

**Moisture content** = 1%

## Atmospheric Humidity

The traditional method for measuring moisture is to measure the relative humidity by using a dry-bulb and a wet-bulb thermometer and to assess the results in a Psychrometric chart (See Chapter The properties of Air).

More modern sensors of conductive instrument type usually have an accuracy of approx. 1% unit.

Such an instrument consists in principle of platinum wires cast in a gelatine block that absorbs more or less moisture and by measuring the resistance across this block.

**Sound** (see the chapter on sound).

### Standards

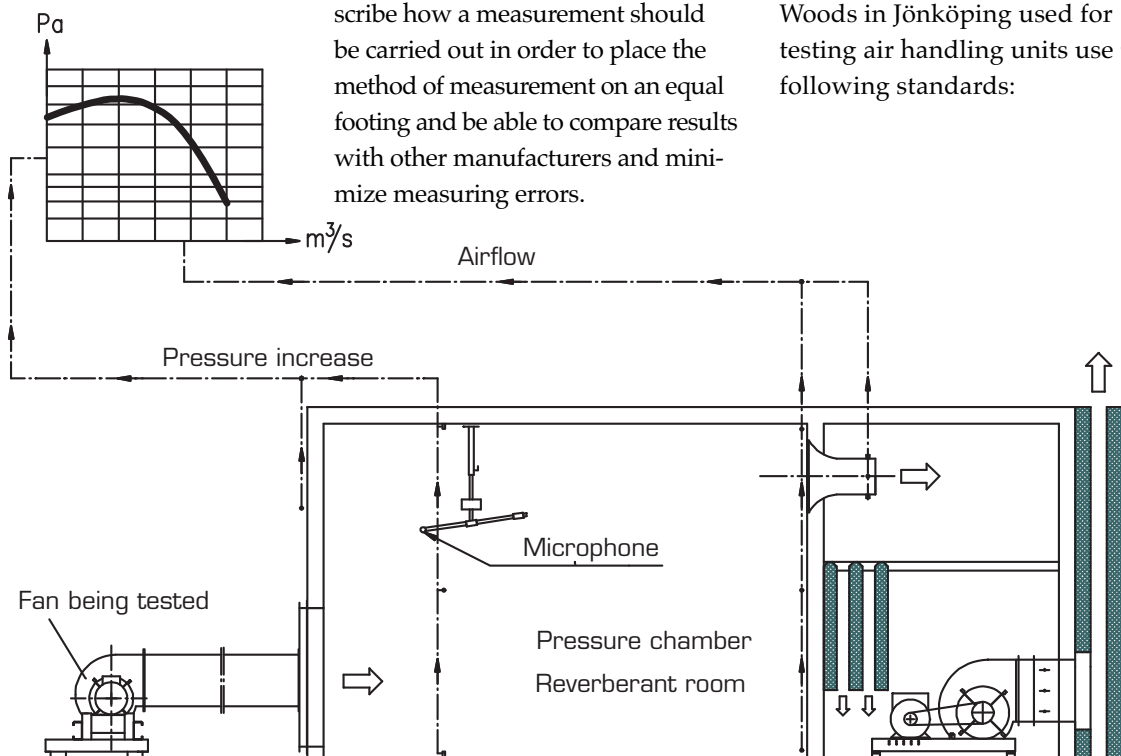

Standards are documents which describe how a measurement should be carried out in order to place the method of measurement on an equal footing and be able to compare results with other manufacturers and minimize measuring errors.

The pressure chambers at Fläkt Woods in Jönköping used for testing air handling units use the following standards:

#### Sound:

Reverberant room: EN ISO 3741  
AMCA 300-96  
BS 848-2  
Outlet: EN ISO 9614:2-3

#### Capacity:

AHU: EN 5801  
AMCA 210-99  
BS 848-1

#### Mechanical:

Leakage: EN 1886 Class L1-L3  
Tensile strength: EN 1886 Class D1-D3  
Filter: EN 1886 G1-F9  
Heat leakage: EN 1886 TB1-TB5

Besides this, motor outputs are also measured by means of an output meter annually calibrated at SP (the Swedish Testing and Research Institute). This is done in order to insure high measurement accuracy.

## Summary



Measurement technology or metrology is the Science of weights and measures, a branch of science in physics and electronics that deals with how various physical quantities are measured.

In the field of air treatment, we take measurements mainly with two purposes in mind: The first is to develop products that offer better performance, to make products more energy efficient, to develop their design, etc. The other main purpose is to produce reference documents for the sizing of products/systems in the form of catalogues and product selection software.

This is also done by means of field measurements, which involves products which are component parts of a system. These field measurements are difficult to carry out and most often do not follow any standard. All measurements that are taken include some error. These errors can be divided up into three categories: Measuring instrument errors, method of measurement errors and reading errors.

### **Temperature**

Temperature measurement is the most common form of measurement. Some of the most common

types of sensors for temperature are thermocouples and resistance gauges.

### **Pressure and flow**

A diaphragm pressure gauge or a water column (U-tube) for instance can be used for measuring pressure.

The most common methods used for determining the airflow involve measuring the air velocity at a number of points and summing them up across a certain range or measuring a pressure drop across some type of throttling device.

### **Moisture**

The traditional method for measuring moisture is to measure the relative humidity by using a dry-bulb and a wet-bulb thermometer and to assess the results in a Mollier chart.

### **Standards**

Standards are documents which describe how a measurement should be carried out in order to place the method of measurement on an equal footing and be able to compare results with other manufacturers and minimize measuring errors.



# 19

## Formulas

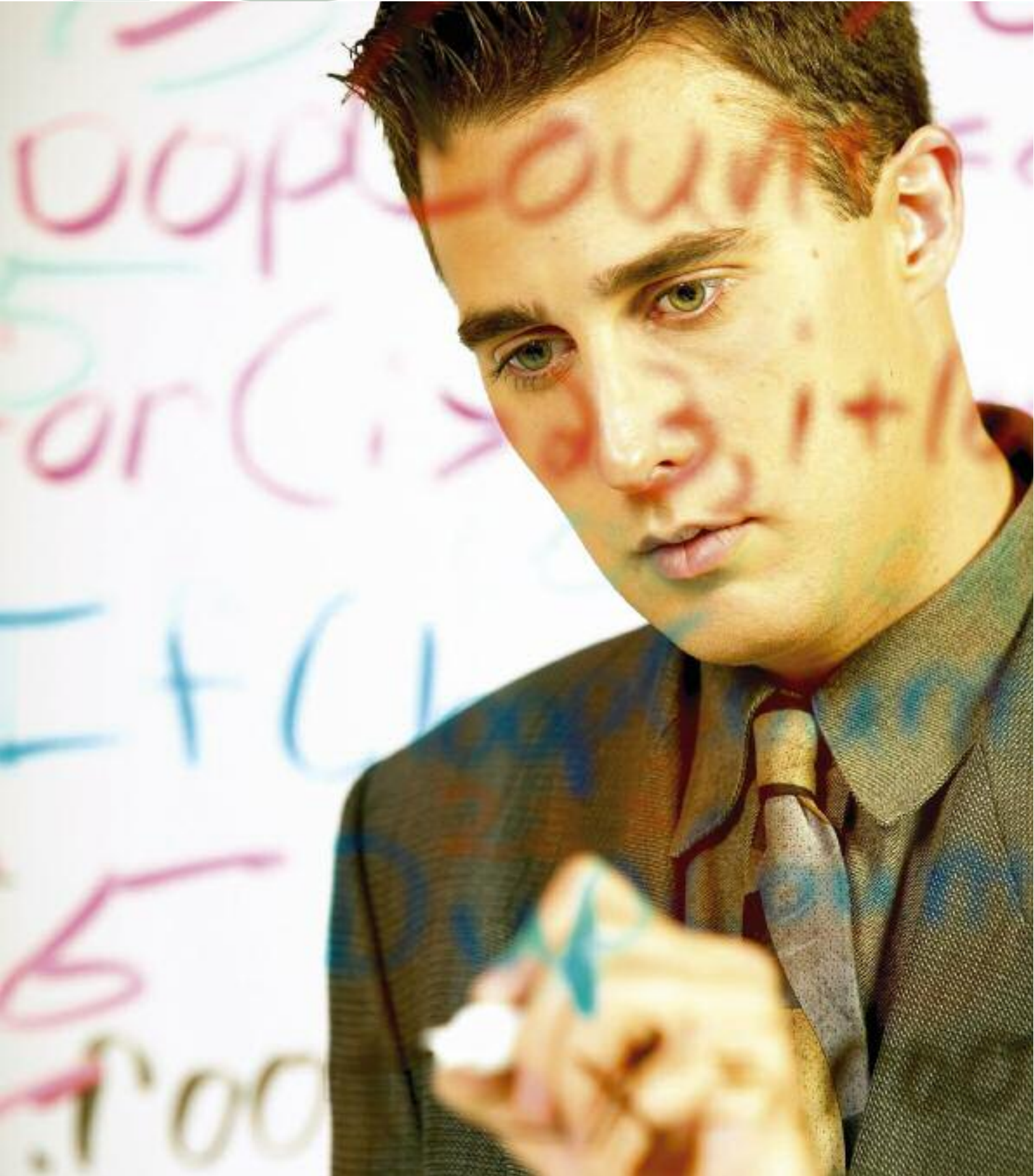

# Collection of Formulas

## Quantities and Units

Quantity		Unit	
L	Length	m	Metre
B	Width	m	Metre
H	Height	m	Metre
A	Area	m <sup>2</sup>	Square metre
V	Volume	m <sup>3</sup>	Cubic metre
t	Time	s	Second
f	Frequency	Hz	Hertz
v	Air velocity	m/s	Metre per second
a	Acceleration	m/s <sup>2</sup>	Metre per second squared
g	Acceleration of free fall	m/s <sup>2</sup>	Metre per second squared
q	Volume flow	m <sup>3</sup> /s	Cubic metre per second
m	Mass flow	kg/s	Kilogram per second
m	Mass	kg	Kilogram
ρ	Density	kg/m <sup>3</sup>	Kilogram per cubic metres
F	Force	N (= kg · m/s <sup>2</sup> )	Newton
E	Energy	J (= Nm)	Joule
P	Power	W (= J/s)	Watt
ps	Static pressure	Pa (= N/m <sup>2</sup> )	Pascal
pd	Dynamic pressure <sup>1)</sup>	Pa	Pascal
pt	Total pressure	Pa	Pascal
ΔPf	Pressure loss	Pa	Pascal
W	Energy, work	J	Joule
T	Absolute temperature	K	Kelvin
t	Dry-bulb temperature	°C	Degrees Celsius
tv	Wet-bulb temperature	°C	Degrees Celsius
td	Dew point	°C	Degrees Celsius
Q	Quantity of heat	J	Joule
cp	Specific heat	J/kg · °C	Joule per kilogram degrees
η	Efficiency	- (%)	Percent
h	Specific enthalpy	J/kg	Joule per kilogram
φ	Relative humidity	- (%)	Percent
M	Molar weight	kg/kmole	Kilogram per kilo mole
n	Quantity of matter (qty. kmol)	-	
R	General gas constant <sup>2)</sup>	8 314 J/(kmol K)	
Lp	Sound pressure level	dB	Decibel
Lw	Sound power level	dB	Decibel

$$^1) p_t = p_s + p_d = p_s + \left( \frac{\rho \cdot v^2}{2} \right)$$

$$^2) p \cdot V = n \cdot R \cdot T$$

## Energy

	Joule (Nm, Ws)	kWh	kpm	kcal
	1	$2,778 \cdot 10^{-7}$	0,1020	$0,2388 \cdot 10^{-3}$
	$3,6 \cdot 10^6$	1	$3,671 \cdot 10^3$	859,8
	9,807	$2,724 \cdot 10^{-6}$	1	$2,342 \cdot 10^{-3}$
	$4,187 \cdot 10^3$	$1,163 \cdot 10^{-3}$	426,9	1

## Power

	Watt (Nm/s, Js)	kpm/s	kcal/s	hk (metric)
	1	0,1020	$0,2388 \cdot 10^{-3}$	$1,360 \cdot 10^{-3}$
	9,807	1	$2,342 \cdot 10^{-3}$	$1,333 \cdot 10^{-2}$
	$4,187 \cdot 10^3$	429,9	1	5,692
	735,5	75	0,1757	1

## Pressure

	Pa (N/m <sup>2</sup> )	bar	kp/cm <sup>2</sup> (atmospheres)	dry (metric)	atm
	1	$10^{-5}$	$1,02 \cdot 10^{-5}$	$7,501 \cdot 10^{-3}$	$9,869 \cdot 10^{-6}$
	$10^5$	1	1,02	750,1	0,9869
	$9,807 \cdot 10^3$	0,9807	1	735,6	0,9678
	133,3	$1,333 \cdot 10^{-3}$	$1,360 \cdot 10^{-3}$	1	$1,316 \cdot 10^{-3}$
	$1,013 \cdot 10^5$	1,013	1,033	760	1

## Temperature

	Kelvin (K)	Celcius (°C)	Fahrenheit (°F)
	x	$x - 273,15$	$x \cdot 9/5 - 459,67$
	$x + 273,15$	x	$x \cdot 9/5 + 32$
	$5/9 \cdot (x - 32) + 273,15$	$5/9 \cdot (x - 32)$	x

## General physical data for water and air

	Chemical formula	Formula weight u	Density $\rho$ kg/m <sup>3</sup>	Dynamic viscosity $10^6 \times \eta$ Ns/m <sup>2</sup>	Thermal conductivity W/(m x K)	Specific thermal capacity $C_p$ kJ(kg x K)	Melting temperature °C	Specific melting enthalpy $l_f$ (r <sub>s</sub> ) kJ/kg	Steam-generating temp. at 1 bar °C	Specific steam-generating enthalpy $l_v$ (r <sub>g</sub> ) kJ/kg
Water*	H <sub>2</sub> O	18	999	1005	0.60	4.18	0	334	100	2260
	Density $\rho$ kg/m <sup>3</sup>	Dynamic viscosity $10^6 \times \eta$ Ns/m <sup>2</sup>	Thermal conductivity W/(m x K)	Specific heat capacity $C_p$ kJ(kg x K)	$C_p / C_v$	Melting temperature °C	Steam-generating temp. °C	Specific melting enthalpy $l_f$ (r <sub>s</sub> ) kJ/kg		
Air**	1.28 1.225***	17.0	25	1.00	1.4	-213	-193	209		

- \* Density and thermal conductivity in 18 °C
- \*\* Density at 0 °C and 1 bar
- \*\*\* Density at sea level

Medium	Temp. °C	Specific thermal capacity $C_p$ J/(kg x °C)	Density $\rho$ kg/m <sup>3</sup>	Thermal conductivity $\lambda$ W/(m x °C)	Dynamic viscosity $10^6 \times \eta$ Pa x s	Kinematic viscosity $10^6 \times \nu$ m <sup>2</sup> /s	Thermal diffusivity $10^6 \times \alpha$ m <sup>2</sup> /s
Water Liquid at p = bar M = 18.016 R = 460 t <sub>crit</sub> = 374.15 °C p <sub>crit</sub> = 221.29 bar	0	4225	999.8	0.559	1792	1.792	0.132
	5	4206	1000	0.568	1519	1.519	0.135
	10	4194	999.7	0.577	1308	1.308	0.138
	20	4181	998.2	0.597	1005	1.004	0.143
	30	4175	995.7	0.615	801	0.805	0.148
	40	4175	992.2	0.633	656	0.661	0.153
	50	4177	988.1	0.647	549	0.556	0.157
	60	4180	983.2	0.659	469	0.477	0.161
	80	4186	977.8	0.668	406	0.417	0.163
	90	4193	971.8	0.674	357	0.367	0.165
Water Liquid at saturation pressure	100	4210	958.4	0.682	284	0.296	0.169
	120	4231	943.5	0.685	232	0.245	0.171
	140	4256	926.3	0.684	196	0.210	0.173
	160	4284	907.6	0.680	174	0.189	0.175
	180	4395	886.9	0.674	152	0.172	0.174
	200	4500	864.7	0.665	139	0.161	0.171
	220	4600	840.3	0.653	125	0.149	0.169
	240	4730	813.6	0.634	114	0.142	0.165
	260	4980	748	0.613	105	0.137	0.158
	280	5230	750.7	0.589	98	0.133	0.151
Water saturated steam	300	5690	712.5	0.565	92	0.130	0.139
	-20	1846	0,00088	0.0172	-	-	8800
	0	1855	0,00484	0.0180	9	1900	2070
	20	1859	0,01734	0.0188	9.5	550	605
	40	1859	0,05118	0.0195	10	196	211
	60	1867	1301	0.0205	11	85	87
	100	1884	0,5984	0.0234	12.5	21	21.3
	200	(1935)	7.857	0.0356	18.6	2.37	1.55
300	(1990)	46.24	0.0605	31.2	0.683	0.66	
Air (dry) gas at p = bar M = 28.96 R = 287 t <sub>crit</sub> = -140.7 °C p <sub>crit</sub> = 36 bar	374,5	(2040)	329	≈0.0110	≈50	≈0.155	≈0.164
	-190		4.2	0.0069	5.5	1.3	
	-150	1027	2.79	0.0115	8.2	3.1	4.0
	-100	1012	2.02	0.0158	11.4	5.6	7.18
	-80	1009	1.81	0.0177	12.6	6.9	8.95
	-40	1005	1.49	0.0209	15.0	10	13.9
	-20	1005	1.38	0.0226	16.0	11.6	16.4
	0	1005	1.276	0.0242	1701	13.4	18.9
	20	1005	1.189	0.0254	18.1	15.2	21.3
	40	1005	1.113	0.0267	19.1	17.2	24.0
	60	1009	1.046	0.0279	20.0	19.1	26.5
	80	1009	0.987	0.0303	20.9	21.2	29.6
	100	1010	0.934	0.0318	21.8	23.3	32.8
	200	1027	0.736	0.0386	25.8	35.0	50.6
	300	1045	0.608	0.0454	29.5	48.5	70.5
	400	1070	0.517	0.0515	32.9	63.5	92.0
	500	1093	0.450	0.0570	35.9	79.8	114
	600	1115	0.399	0.0623	38.8	97	138
	700	1135	0.358	0.0668	41.5	115	162
	800	1152	0.324	0.0707	44.0	135	186
	900	1168	0.297	0.0742	46.5	155	210
	1000	1184	0.273	0.0770	48.8	179	237
1100	1192						
1200	1205						
1300	1215						
1400	1222						
1500	1230						
1750	1245						
2000	1260						

# Formulas

## The Properties of Air

---

---

**The following formula can be used for calculating the required heat output (P):**

$$P = \Delta h \cdot q_v \cdot \rho_t = (h_B - h_A) \cdot q_v \cdot \rho_t$$

Where

$P$  = Heat output kW

$\Delta h$  = Change in enthalpy

$q_v$  = Air flow with moist air/s

$\rho_t$  = Density kg dry air/m<sup>3</sup> moist air

### Mixing of two air flows

$$B = \frac{m_1 \cdot x_1 + m_2 \cdot x_2}{m_1 + m_2}$$

Where

$B$  = Mixing point kg/kg

$m$  and  $m_2$  = Air volume in point and squared

## Fluid Engineering

---

---

### Reynolds Number

$$Re = \frac{wd}{\nu}$$

Where

$w$  = Mean velocity of the fluid m/s

$L$  = A characteristic length of the body

(for flow in a tube  $L = d =$  tube diameter m)

$\nu$  = Kinematical viscosity of the fluid m<sup>2</sup>/s

### Bernoulli's simplified equation

$$\frac{P_s}{\rho} + \frac{1}{2} \cdot v^2 = constant$$

Where

$P_s$  = Static pressure, Pa

$\rho$  = Density, kg/m<sup>3</sup>

$v$  = Air velocity, m/s

If we multiply the formula above by the density we obtain the following equation.

$$P_s + \frac{\rho}{2} \cdot v^2 = P_s + P_d = P_t = constant$$

Where

$P_s$  = Static pressure, Pa

$\rho$  = Density, kg/m<sup>3</sup>

$v$  = Air velocity, m/s

$P_d$  = Dynamic pressure, Pa

$P_t$  = Total pressure, Pa

### Pressure losses

$$\Delta P_\lambda = \lambda \cdot \frac{L}{d} \cdot \frac{\rho}{2} \cdot v^2$$

Where

$d$  = Duct diameter, m

$L$  = Duct length, m

$v$  = Air velocity, m/s

$\rho$  = Density, kg/m<sup>3</sup>

$\lambda$  = Friction factor depending on the Reynold's number or the coarseness of the surface on the duct wall

The following formula can be used for calculating the friction factor ( $\lambda$ ):

**For laminar flow (Re ≤ 2320):**

$$\lambda = \frac{64}{Re}$$

**For turbulent flow (Re ≥ 2320):**

$$\frac{1}{\sqrt{\lambda}} = 1,14 - 2 \log \cdot \frac{k}{d}$$

Where

$k$  = Roughness of the surface on the duct wall, mm

$d$  = Duct diameter, m

### Pressure losses caused by a flow-directional change inside duct

**The following formula can be used for calculating the pressure loss:**

$$\Delta P_f = \xi \cdot \frac{\rho}{2} \cdot v^2$$

Where

$\xi$  = One-time loss coefficient

$\rho$  = Density, kg/m<sup>3</sup>

$v$  = Air velocity, m/s

### Bernoulli's extended equation

$$P_1 + \frac{\rho \cdot v_1^2}{2} + \rho g h_1 = P_2 + \frac{\rho \cdot v_2^2}{2} + \rho g h_2 + \Delta P_\lambda$$

Where

$P$  = Static pressure referred to height  $h = 0$ , Pa

$\rho$  = Density, kg/m<sup>3</sup>

$v$  = Air velocity, m/s

$g$  = Acceleration of free fall, m/s<sup>2</sup>

$h$  = Height, m

$\Delta P_f$  = Pressure losses, Pa

$\rho \cdot \frac{v^2}{2}$  = Dynamic pressure

$\rho g h$  = Height pressure

## Heat Transfer

### Fouriers law

$$q = -\lambda \cdot \frac{dt}{dn} \quad [W/m^2]$$

Where

$\lambda$  denotes the thermal conductivity of the material

$\frac{dt}{dn}$  denotes the temperature gradient in the direction of surface roughness

The following is obtained for a flat wall:

$$q = -\lambda \cdot \frac{dt}{dy} = -\lambda \cdot \frac{(t_2 - t_1)}{\delta} = \lambda \cdot \frac{(t_1 - t_2)}{\delta} \quad [W/m^2]$$

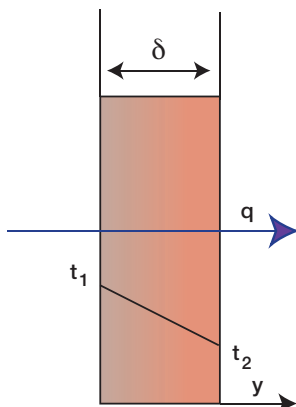

For a circular tube:

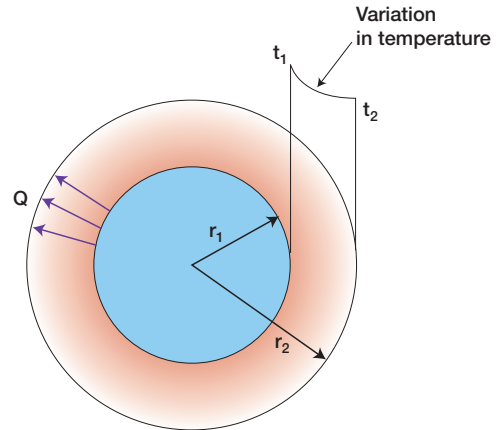

$$Q = -2\pi \cdot r \cdot \lambda \cdot \frac{dt}{dr} \quad [W]$$

But, then  $Q$  is conditional on that  $r$  is obtained on integrating the heat flow per unit of length to

$$Q = -2\pi \cdot \lambda \cdot \frac{t_2 - t_1}{\ln \frac{r_2}{r_1}} \quad [W]$$

### The insulation factor

$$k_b = \frac{(t_s - t_i)}{(t_e - t_i)}$$

Where

$t_i$  = Air temperature inside the air handling unit

$t_e$  = Temperature of the surroundings

$t_s$  = Lowest surface temperature of the unit section

## Cooling Processes

### The cooling process

$$Q = m \cdot (h_c - h_b)$$

Where

$Q$  = Cooling capacity, kW

$m$  = Mass flow of the refrigerant, kg/s

$h_c - h_b$  = Change in enthalpy from  $b$  to  $c$ ,

See illustration on page 34

## Power demand

$$P = m \cdot (h_d - h_c)$$

Where

$P$  = Power demand, kW

$m$  = Mass flow of the refrigerant, kg/s

$(h_d - h_c)$  = Change in enthalpy from c to d,

See illustration on page 34

## Coefficient of performance, cooling

$$COP_2 = \frac{Q}{P} = \frac{m \cdot (h_c - h_b)}{m \cdot (h_d - h_c)}$$

Where

$COP_2$  = Coefficient of performance

$Q$  = Cooling capacity, kW

$P$  = Power demand, kW

$$COP_2 = \frac{(h_c - h_b)}{(h_d - h_c)}$$

## Coefficient of performance, heating

$$COP_1 = \frac{(h_d - h_a)}{(h_d - h_c)}$$

Since  $(h_d - h_a) = (h_c - h_b) + (h_d - h_c)$

it follows that  $COP_1 = COP_2 + 1$

## Power demand for heating air

$$P = Cp \cdot \rho \cdot \Delta t$$

$$P = 1.2 \cdot \Delta t$$

Where

$P$  = Power demand, kW

$Cp$  = Specific thermal capacity

$\rho$  = Density, kg/m<sup>3</sup>

$\Delta t$  = Temperature, °C

## Power demand for heating pure water

$$P = Cp \cdot \rho \cdot \Delta t$$

$$P = 14.18 \cdot \Delta t$$

Where

$P$  = Power demand, kW

$Cp$  = Specific thermal capacity

$\rho$  = Density, kg/m<sup>3</sup>

$\Delta t$  = Temperature, °C

# Heat and Cooling Energy Recovery

## Annual heating load

$$Q_{tot} = q \cdot \rho \cdot c_p \cdot \text{number of degree hours}$$

Where

$Q_{tot}$  = Annual heat requirement, kWh/year  
without heat exchanger

$q$  = Air flow, m<sup>3</sup>/s

$\rho$  = Density kg/m<sup>3</sup>

$c_p$  = Thermal capacity, J/kg · °C

## Incidental heat gain

$$Q_{rest} = \left( 1 - \frac{\eta_{\text{mean annual year}}}{100} \right) \cdot Q_{tot}$$

Where

$Q_{rest}$  = Annual heat requirement, kWh/year  
with heat exchanger

$\eta_{\text{mean annual year}}$  = Annual mean efficiency of the  
heat exchanger, %

$Q_{tot}$  = Annual heat requirement, kWh/year  
without heat exchanger

## Efficiency

$$\eta_t = \frac{t_{22} - t_{21}}{t_{11} - t_{21}}$$

$$\eta_x = \frac{x_{22} - x_{21}}{x_{11} - x_{21}}$$

## Symbols used:

$q$  = Air flow, m<sup>3</sup>/s

$t$  = Temperature, °C

$\phi$  = Relative humidity of the air, %

$\eta_t$  = Temperature efficiency, %

$\eta_x$  = Moisture efficiency, %

## Index

1 = Extract air side

2 = Supply air side

11 = Extract air, inlet

12 = Extract air, outlet

21 = Supply air, inlet

22 = Supply air, outlet

## Heat Transfer Unit

Heat transfer units can be expressed as follows:

$$N_{tu} = \frac{\alpha \cdot F}{C_{min}}$$

$$C_{min} = q_{min} \cdot \rho \cdot Cp$$

Where

$\alpha$  = Surface coefficient of heat transfer, W/m<sup>2</sup> °C

$F$  = Heat transfer surface, one side m<sup>2</sup>

$\rho$  = Density kg/m<sup>3</sup>

$q_{min}$  = Lowest flow, m<sup>3</sup>/s

$Cp$  = Specific thermal capacity

## Sound

### Sound pressure level

The sound pressure level is defined as follows:

$$Lp = 20 \log \left( \frac{P}{P_0} \right) = 20 \log \left( \frac{P}{2 \cdot 10^{-5}} \right)$$

Where

$Lp$  = Sound pressure level, dB

$P$  = Sound pressure, Pa

$P_0$  = Reference value, Pa

### Sound power level

The sound power level is defined as follows:

$$Lw = 10 \log \left( \frac{W}{W_0} \right) = 10 \log \left( \frac{W}{10^{-12}} \right)$$

Where

$Lw$  = Sound power level, dB

$W$  = Sound power, W

$W_0$  = Reference value, Pa

### Addition of sound levels

$$Lp = 10 \log \left( 10^{\frac{Lp_1}{10}} + 10^{\frac{Lp_2}{10}} \right)$$

### Sound velocity

$$c = f \lambda$$

Where

$c$  = Velocity, m/s

$f$  = Frequency, Hz

$\lambda$  = Wave length, m

### Sound pressure level in duct

#### Sound pressure level in a duct:

$$Lp = Lw - 10 \log A$$

Where

$Lp$  = Sound pressure level, dB

$Lw$  = Sound power level, dB

$A$  = Cross sectional area of duct, m<sup>2</sup>

### Sound pressure level outdoors

The sound pressure level at radius  $r$  from a sound source is specified as follows:

$$Lp = Lw - 10 \log 2\pi r^2$$

Where

$Lp$  = Sound pressure level, dB

$Lw$  = Sound power level, dB

$r$  = Radius, m

### Sound absorption in a room

$$A = A_1 \cdot \alpha_1 + A_2 \cdot \alpha_2 + A_3 \cdot \alpha_3 + \dots + A_n \cdot \alpha_n$$

Where

$A$  = Equivalent sound absorption area, m<sup>2</sup>

$A1-n$  = Area for the individual surfaces in the room

$\alpha$  = Sound absorption coefficient

### Reverberant field

$$T = 0.16 \cdot \frac{V}{A}$$

Where

$T$  = Reverberant time, s

$V$  = Room volume, m<sup>3</sup>

$A$  = Equivalent sound absorption area, m<sup>2</sup>



# Fans

## Fan laws

$$\text{Air flow } \frac{q_1}{q_2} = \frac{n_1}{n_2}$$

$$\text{Pressure } \frac{\Delta p_1}{\Delta p_2} = \left(\frac{n_1}{n_2}\right)^2$$

$$\text{Power demand } \frac{P_1}{P_2} = \left(\frac{n_1}{n_2}\right)^3$$

Where

$q$  = Air flow, m<sup>3</sup>/s

$n$  = Speed, revolutions/min

$p$  = Pressure, Pa

$P$  = Power, kW

## System characteristics for a normal duct system

$$P = P_0 + k \cdot q^n$$

Where

$P$  = Pressure, Pa

$P_0$  = Pressure at zero flow, the constant pressure, Pa

$k$  = System constant

$n$  = System exponent, which normally is close to 2

## The fan efficiency

$$\eta_f = \frac{P_f}{P_R} = \frac{k_p \cdot q_{vi} \cdot p_{tf}}{P_R}$$

Where

$\eta_f$  = Fan efficiency, %

$P_f$  = Fan power demand, W

$P_R$  = Fan impeller output, W

$k_p$  = Compressibility factor

$q_{vi}$  = Fan air flow velocity at the inlet, m<sup>3</sup>/s

$p_{tf}$  = Total fan pressure rise, Pa

## Temperature rise through the fan

$$\Delta t = \frac{k_p \cdot P_{tf}}{\rho \cdot \eta \cdot c_p}$$

Where

$\Delta_t$  = Temperature rise, °C or K

$k_p$  = Compressibility factor which can be disregarded

$p_{tf}$  = Total fan pressure rise, Pa

$\eta$  = Fan efficiency

$\rho$  = Air density, kg/m<sup>3</sup>

$C_p$  = Specific heat factor

As a rule of thumb we can estimate  $\rho = 1.2$ ,  $\eta = 0.80$

and  $C_p = 1008$  and therefore

$\Delta t \approx P/1000$  or 1°C per 1000Pa.

## Temperature rise for motors with belt drive

$$\Delta t = \frac{k_p \cdot p_{tf}}{\rho \cdot \eta_f \cdot \eta_m \cdot \eta_{tr} \cdot c_p}$$

Where

$\Delta t$  = Temperature rise, °C or K

$k_p$  = Compressibility factor which is negligible

$p_{tf}$  = Total fan pressure rise, Pa

$\eta_f$  = Fan efficiency

$\eta_m$  = Motor efficiency

$\eta_{tr}$  = Transmission efficiency

$\rho$  = Air density, kg/m<sup>3</sup>

$C_p$  = Specific thermal capacity

## Sound power level per octave band

$$L_{Wokt(s)} = L_{WA} + K_{okt(s)}$$

Where

$L_{Wokt(s)}$  = Sound power level per octave band, dB

$L_{WA}$  = A-weighted sound power levels, dB

$K_{okt(s)}$  =  $K_{okt}$  is a factor for correcting each individual octave band conditional on the fan speed

## Starting time for motors without frequency inverter

### For calculating the starting time:

- Select a motor with rated output,  $P$ , based on the fan power demand,  $P_f$ , at a normal duty point, (= open guide vanes/damper).
- Set the value  $P_f$  = fan power demand for closed guide vanes/damper, in the formula for calculating the starting time.

### Use the following formula:

$$t = \frac{J \cdot n^2 \cdot 10^{-3}}{46 \left( P \left( \frac{M_{max}}{M} + \frac{M_{st}}{M} \right) - P_f \right)}$$

The estimated starting time is the time it takes to accelerate the fan from rest to full speed..

Use the following formula for calculating the starting time for Y/D-start:

$$t = \frac{J \cdot n_f^2 \cdot 10^{-3}}{46 \left( P \left( \frac{1}{3} \times \frac{M_{max}}{M} + \frac{1}{4} \times \frac{M_{st}}{M} \right) + P_f \right)}$$

The calculated starting time is the time during which the star-delta starter must be in star connection for the fan to reach approx. 90 % of full speed, whereupon it switches over to delta connection. For star/delta starting, a check must also be made to ensure that the motor torque is higher than the fan torque during the star connection phase.

#### Symbols used:

$P$  = Rated output of the motor, kW

$P_f$  = Fan power demand at rated speed, kW  
(Incl. belt-drive losses)

$P_{Y/D}$  = minimum motor rating at which star-delta starting is possible, kW

$M_{st}/M$  = Ratio of motor starting torque to normal torque

$M_{max}/M$  = Ratio of motor max. torque to normal torque

$n_f$  = Rated motor speed rpm

$J$  = moment of inertia of the system referred to the fan shaft, kgm<sup>2</sup>

## SFP

### Specific fan power for an entire building

$$SFP = \frac{\Sigma P_{mains}}{q_{max}}$$

$SFP$  = Specific fan power demand if the building

$P_{n\dot{a}t}$  = Sum of mains power supplied to all the fans in the building, kW

$q_{max}$  = The building's highest measurable design supply air or extract air flow, m<sup>3</sup>/s

## SFP<sub>v</sub>

### Specific fan power demand for heat recovery units with supply air and extract air fans

$$SFP_v = \frac{P_{mains_{TF}} + P_{mains_{FF}}}{q_{max}}$$

$SFP_v$  = Specific fan power demand of the heat recovery unit, kW/(m<sup>3</sup>/s)

$P_{mains_{TF}}$  = Fan power of the supply air fan, kW

$P_{mains_{FF}}$  = Fan power of the extract air fan, kW

$q_{max}$  = Highest supply air or extract air flow of the air handling unit, m<sup>3</sup>/s

## The fan power

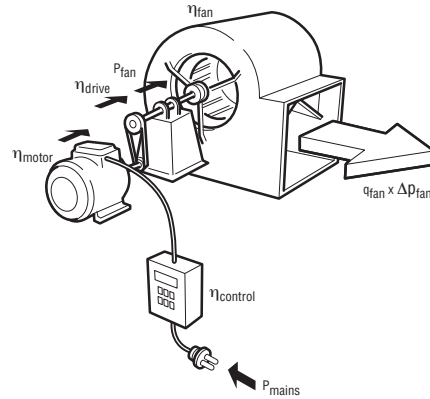

### Calculation of the fan mains power, P<sub>mains</sub>

$$P_{mains} = \frac{q_{fan} \cdot \Delta p_{fan}}{\eta_{fan} \cdot \eta_{transmission} \cdot \eta_{motor} \cdot \eta_{controls} \cdot 1000}$$

$\eta$  = Efficiencies for fan, transmission, motor and control equipment (see figure).

For a unit with rotary heat exchanger, the calculation of the mains power demand for the extract air fan motor shall include the power used for leakage and heat-exchanger purging air flows. Any throttling on the extract air side necessary for achieving the correct pressure balance and direction of air leakage in the unit shall also be included.

## Pressure

$$p = \frac{F}{A} = \frac{\rho \cdot g \cdot h \cdot A}{A} = \rho \cdot g \cdot h$$

Where

$p$  = Pressure, Pa

$F$  = Force, N

$A$  = Area, mm<sup>2</sup>

$\rho$  = Density, mm<sup>3</sup>

$g$  = Acceleration of free fall, m/s<sup>2</sup>

$h$  = Height, m

## Volumetric flow

$$q_v = A \cdot v$$

Where

$A$  = Cross sectional area, m<sup>2</sup>

$v$  = Velocity, m/s

# List of Sources

- Fläkt Woods documentation
  - Syftet med luftbehandling(The Purpose of Air Handling), SEFLE 4267 SE 2001.12
  - Lufttegenskaper (The Properties of Air), SEFLE 4268 SE 2001.12
  - Luftbehandlingsprocesser (Air Handling Processes), SEFLE 4269 SE 2002.08
  - Kylning (Cooling), SEFLE 4270 SE 2002.08
  - Strömningslära – Värmeöverföring – Batteriteknik (Fluid Engineering – Heat Transfer – Coil Technology), SEFLE 4271 SE 2001.06
  - Ljud (Sound), SEFLE 4272 SE 2002.08
  - Mätteknik och Standarder (Measurement Technology and Standards), SEFLE 4274 SE 2000.10
  - Spjäll (Air Dampers), SEFLE 4275 SE 2002.08
  - Air Filters, SEFLE 4276 GB 2002.08
  - Värmeåtervinnare (Exchangers for Recovering Heat), SEFLE 4279 SE 2002.08
  - Luftbefuktare (Air Humidifiers), SEFLE 4280 SE 2002.08
  - Fläktar (Fans), SEFLE 4282 SE 2001.12
  - Indirekt evaporativ kyla (Indirect Evaporative Cooling), SEFLE 4283 SE 2002.07
  - Elektrisk teknologi (Electric Engineering), SEFLE 4290 SE 2002.02
- Fläkt Woods Inneklimatsystem, FWG–Inneklimathandbok (Fläkt Woods Indoor Climate Systems, FWG–Indoor Climate Manual) –SE–08–8686
- Fläkt Woods Product Catalogues
  - Luftbehandlingsaggregat EU (EU Air Handling Units), Fläkt Woods 8009SE 2007.10
  - Luftbehandlingsaggregat EC (EC Air Handling Units), Fläkt Woods 8376SE 2007.08
- Basics of Modern Fan and Ventilation Technology, ABB SEIND Dep. FMVM 1997-09 100
- Medarbetare vid Fläkt Woods AB (The Co-workers at Fläkt Woods AB)
- Modern Reglerteknik (Modern Control Engineering), 2nd edition, Liber ISBN-91-47-01305-2, 1999
- Regler handbok (Controls Manual), ISBN-91-643-0630-6













# Notes

A series of horizontal dotted lines for writing notes, spanning the width of the page.

# We Bring Air to Life

Fläkt Woods is a global leader in air management. We specialise in the design and manufacture of a wide range of air climate and air movement solutions. And our collective experience is unrivalled.

Our constant aim is to provide systems that precisely deliver required function and performance, as well as maximise energy efficiency.

## Solutions for all your air climate and air movement needs

Fläkt Woods is providing solutions for ventilation and air climate for buildings as well as fan solutions for Industry and Infrastructure.

### ● Air Handling Units (AHUs)

Modular, compact and small AHU units. Designed to ensure optimisation of indoor air quality, operational performance and service life.

### ● Air Terminal Devices and Ducts

Supply and exhaust diffusers and valves for installation on walls, ceiling or floor are all included in our large range and fit all types of applications.

### ● Chilled Beams

Active induction beams for ventilation, cooling and heating, and passive convection beams for cooling. For suspended or flush-mounted ceiling installation – and multi-service configuration.

With unique Comfort Control and Flow Pattern Control features.

### ● Residential ventilation

A complete range of products for residential ventilation. Consists of ventilation units, exhaust air fans and cooker hoods designed to optimise indoor comfort and save energy.

### ● Fans

Advanced axial, centrifugal and boxed fans for general and specialist applications. Comprehensive range including high temperature and ATEX compliant options. Engineered for energy efficiency and minimised life cycle cost.

### ● Chillers

Air-cooled and water-cooled chillers with cooling capacity up to 1800kW. Designed to minimise annual energy consumption in all types of buildings.

### ● Controls and drives

Variable speed drives and control systems, all tested to ensure total compatibility with our products. Specialist team can advise on energy saving and overall system integration.

## Fläkt Woods Group SA

18, avenue Louis Casar, CH-1209 Geneva, Switzerland

Tel. +41 22 309 3800

email [info@flaktwoods.com](mailto:info@flaktwoods.com) [www.flaktwoods.com](http://www.flaktwoods.com)

See global website for international sales offices [www.flaktwoods.com](http://www.flaktwoods.com)

The logo for Fläkt Woods, featuring the company name in a bold, green, sans-serif font. A stylized green swoosh or arc is positioned above the 't' in 'Woods' and below the 'ä' in 'Fläkt'.